

SÜRME SİSTEM
SLIDE SYSTEM

$KX = \frac{L-36}{2}$
$KY = H-76$
$G = B+28$

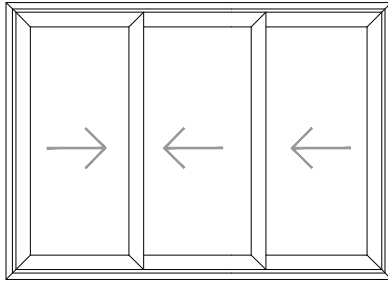
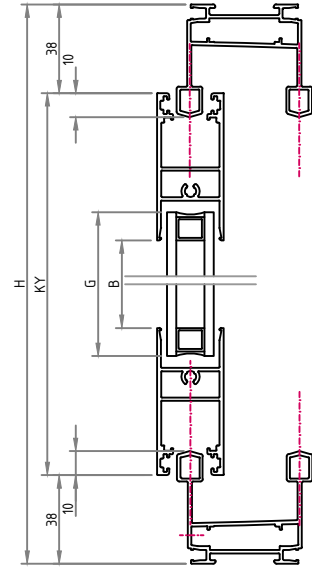
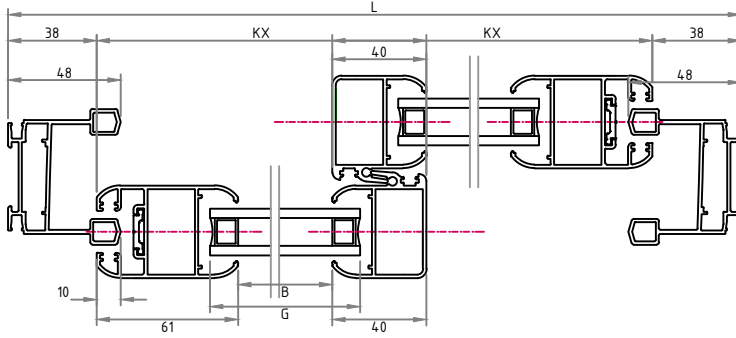

$KX = \frac{L-76}{3}$
$KY = H-76$
$G = B+28$

SÜRME SİSTEM
SLIDE SYSTEM

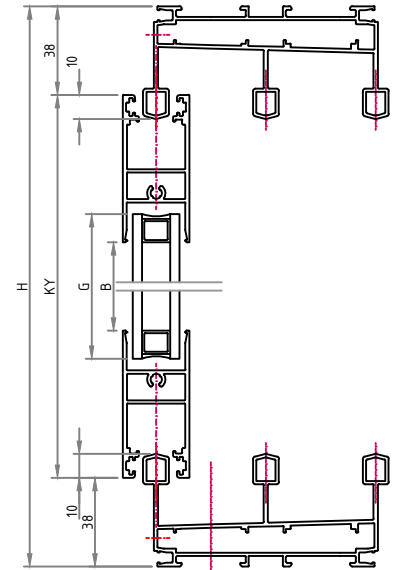
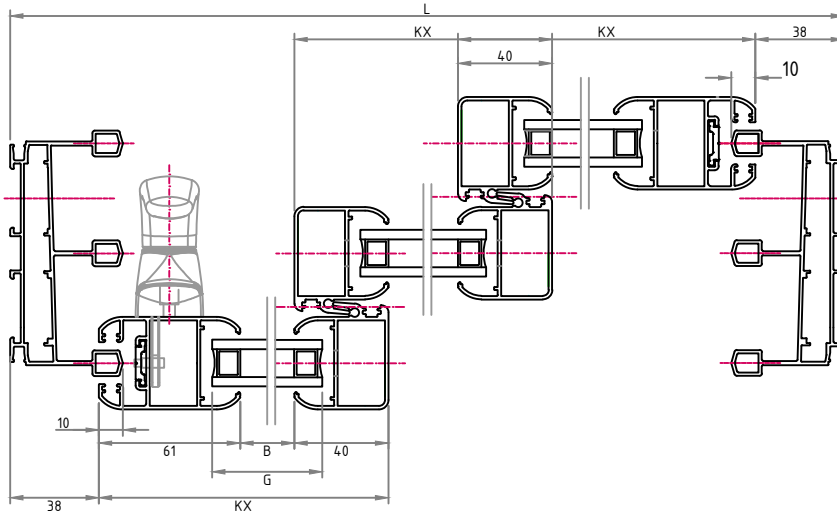

S40 SÜRME SERİ S40 SLIDE SYSTEM

Max 80 Kg

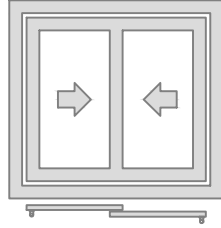

Max 160 Kg

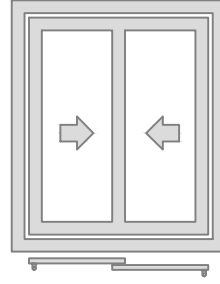

AÇILIM TİPLERİ OPENING STYLES

2 KANATLI 2 SASHES

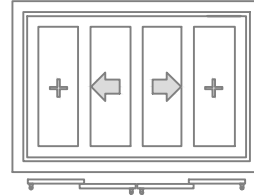
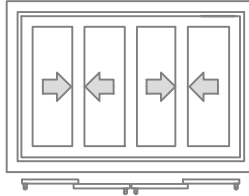
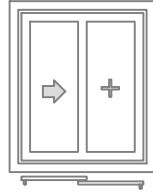
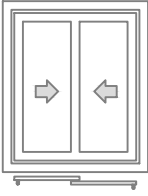

3 KANATLI 3 SASHES

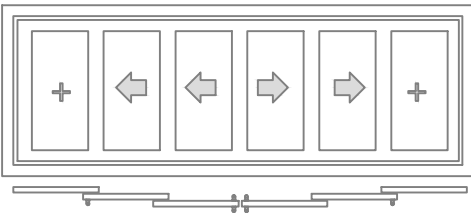
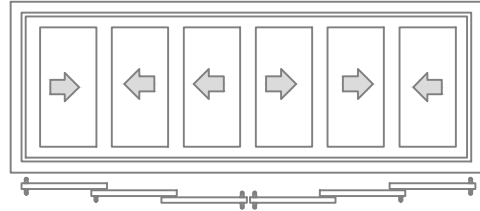
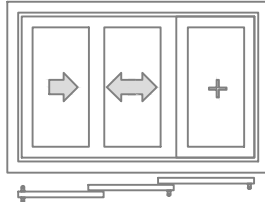
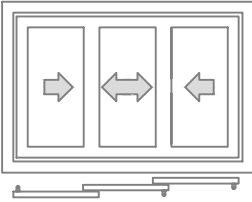

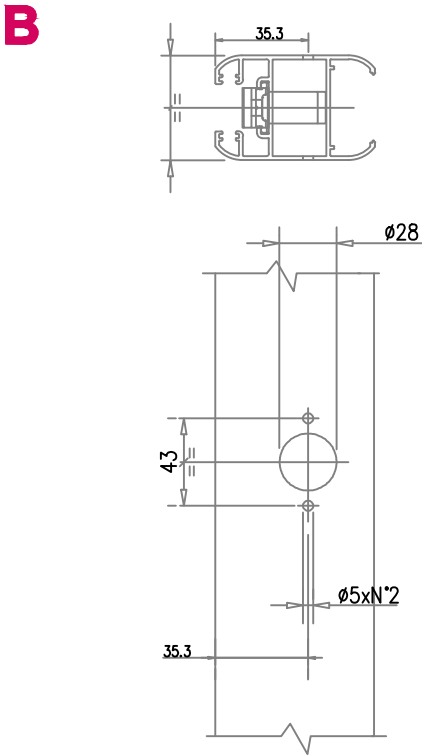
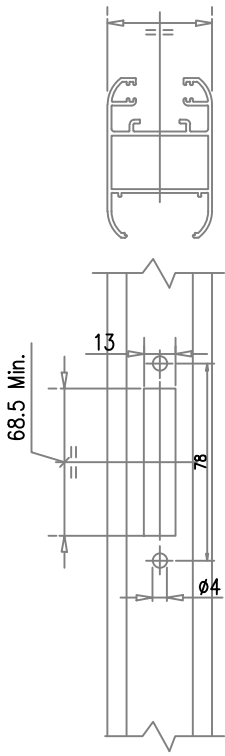
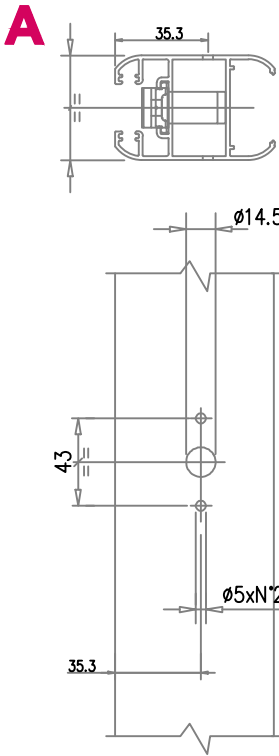
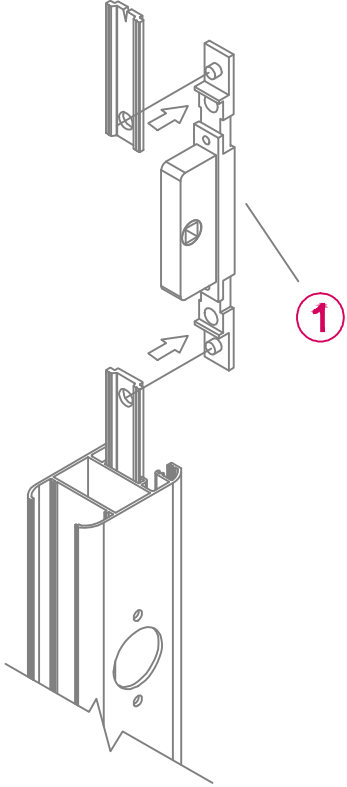
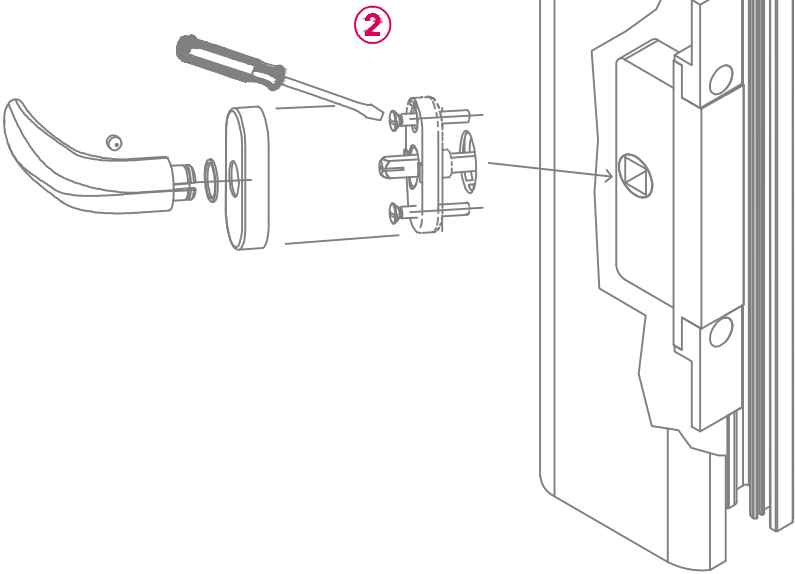
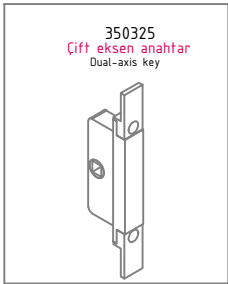

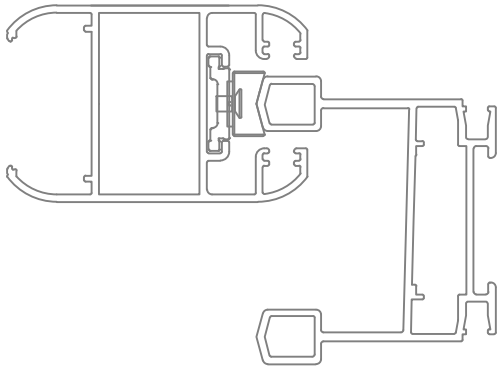
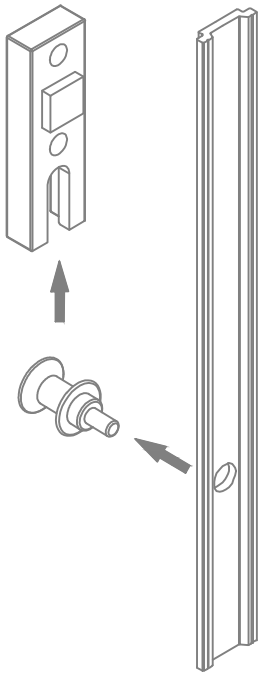
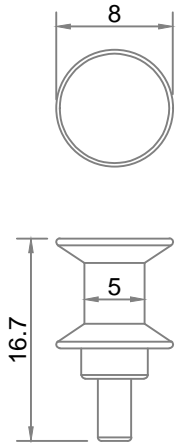
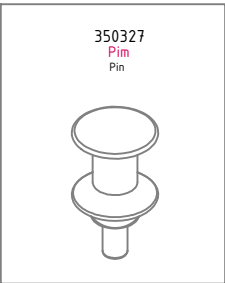
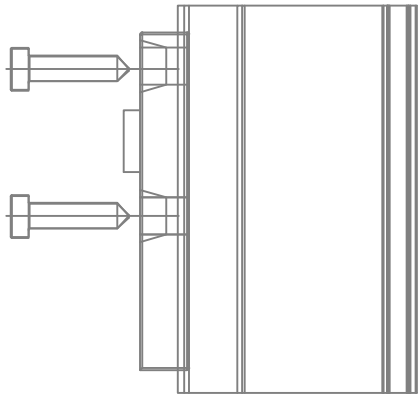
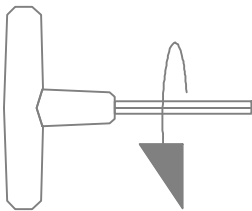
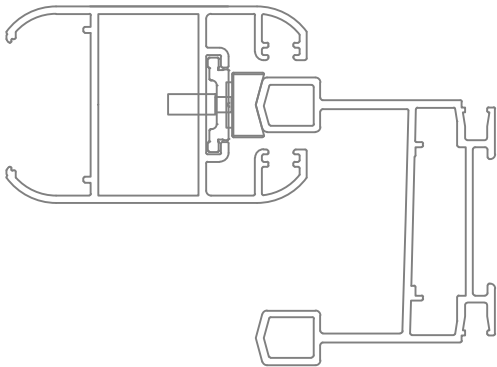
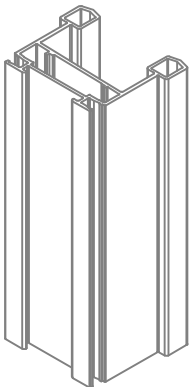
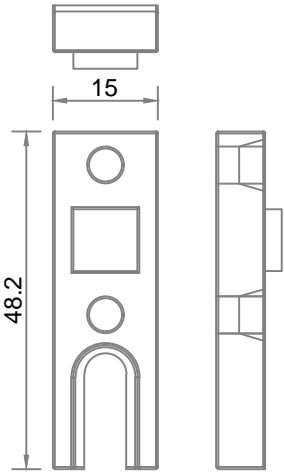

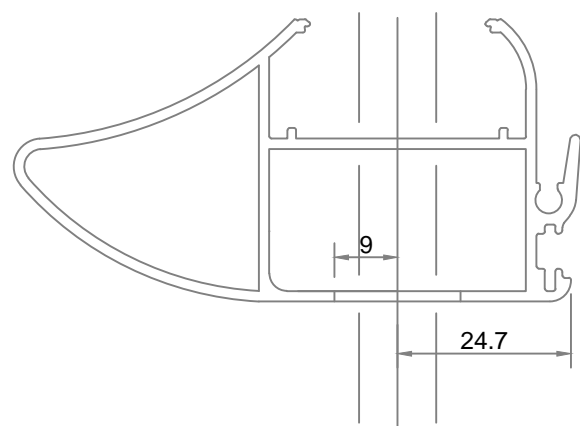
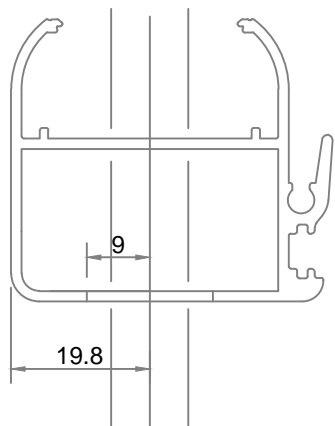
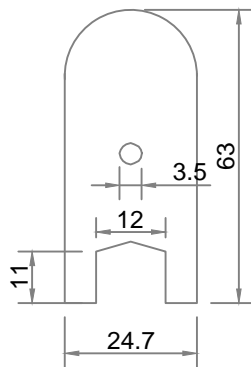
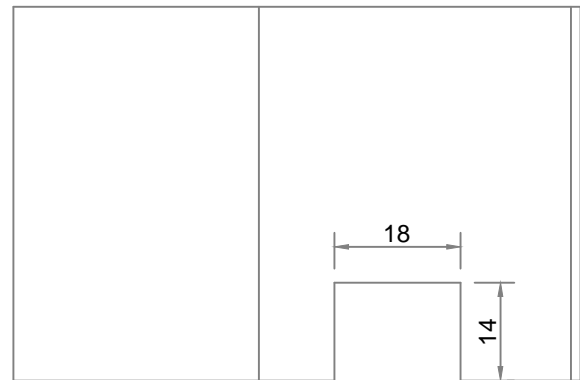
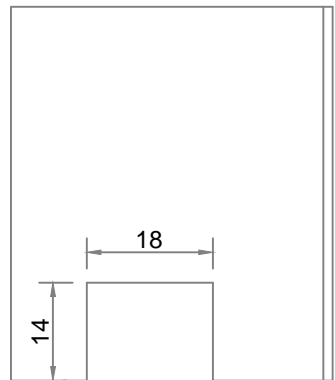
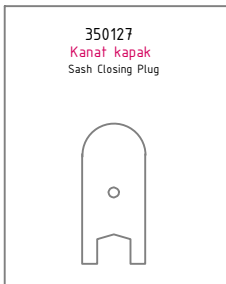
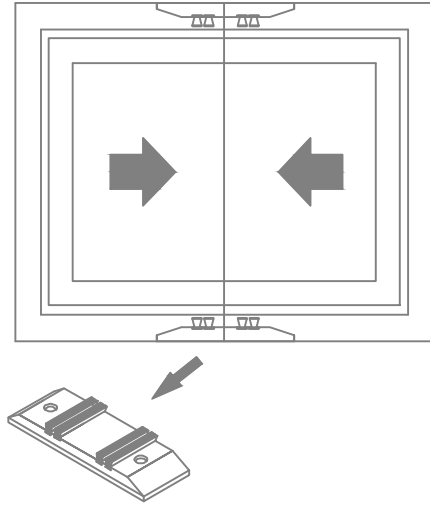
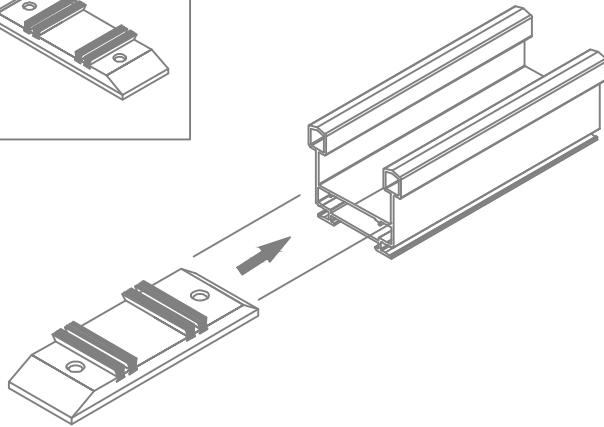

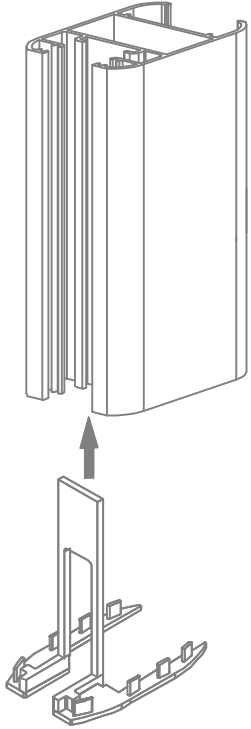
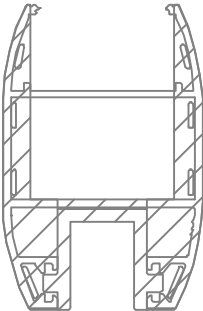
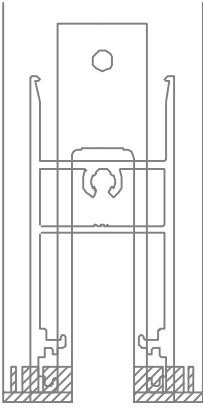
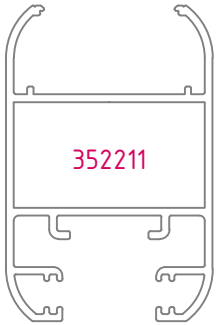
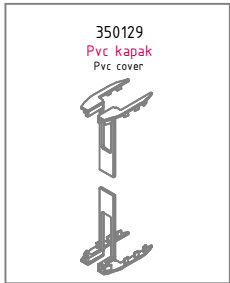
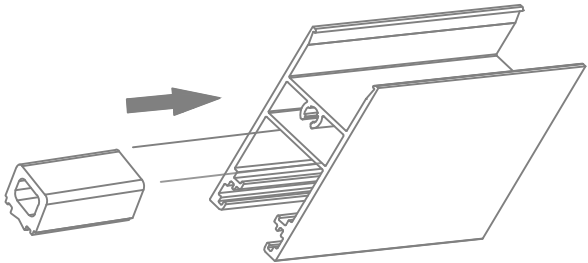
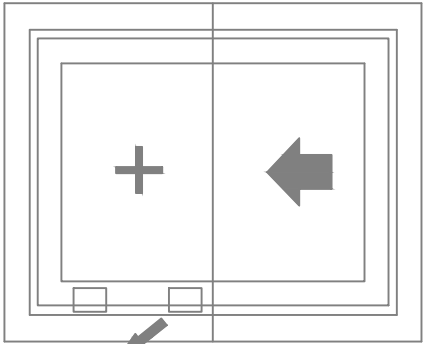
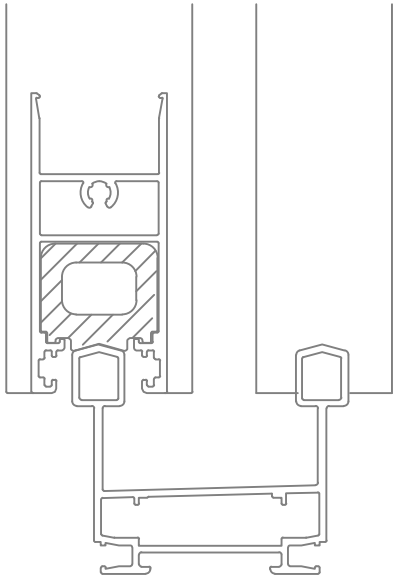
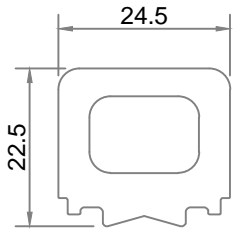

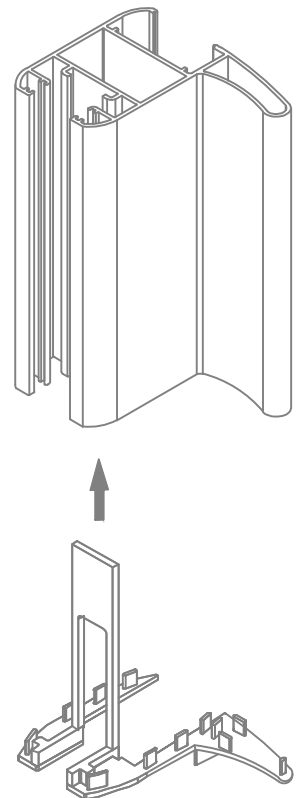
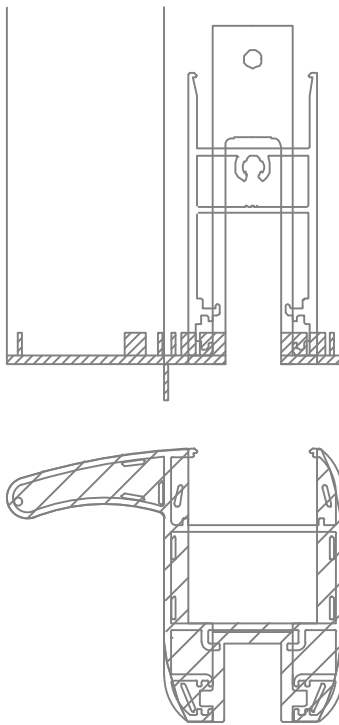
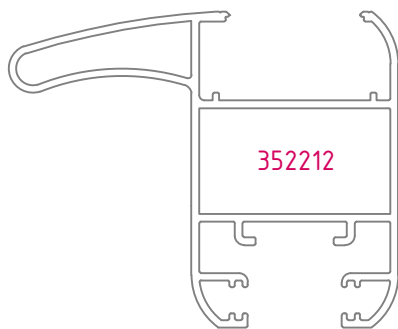
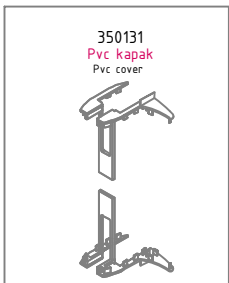
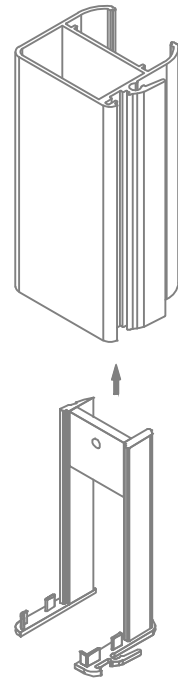
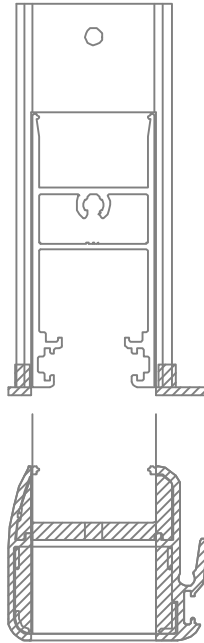
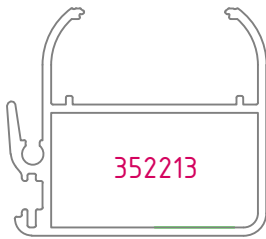
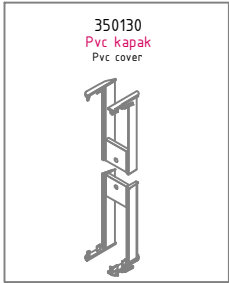

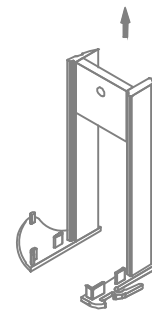
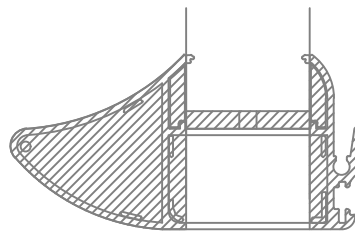
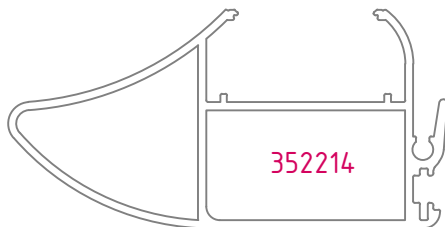
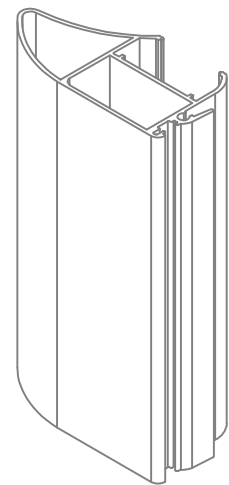
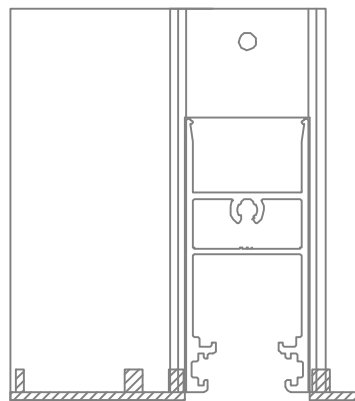
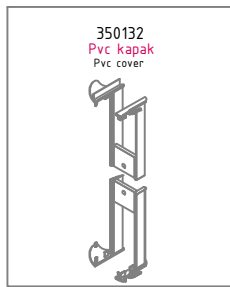

350324
Prima aksel kol
Prima handle