

DÜŞEY DETAYI  
VERTICAL DETAIL

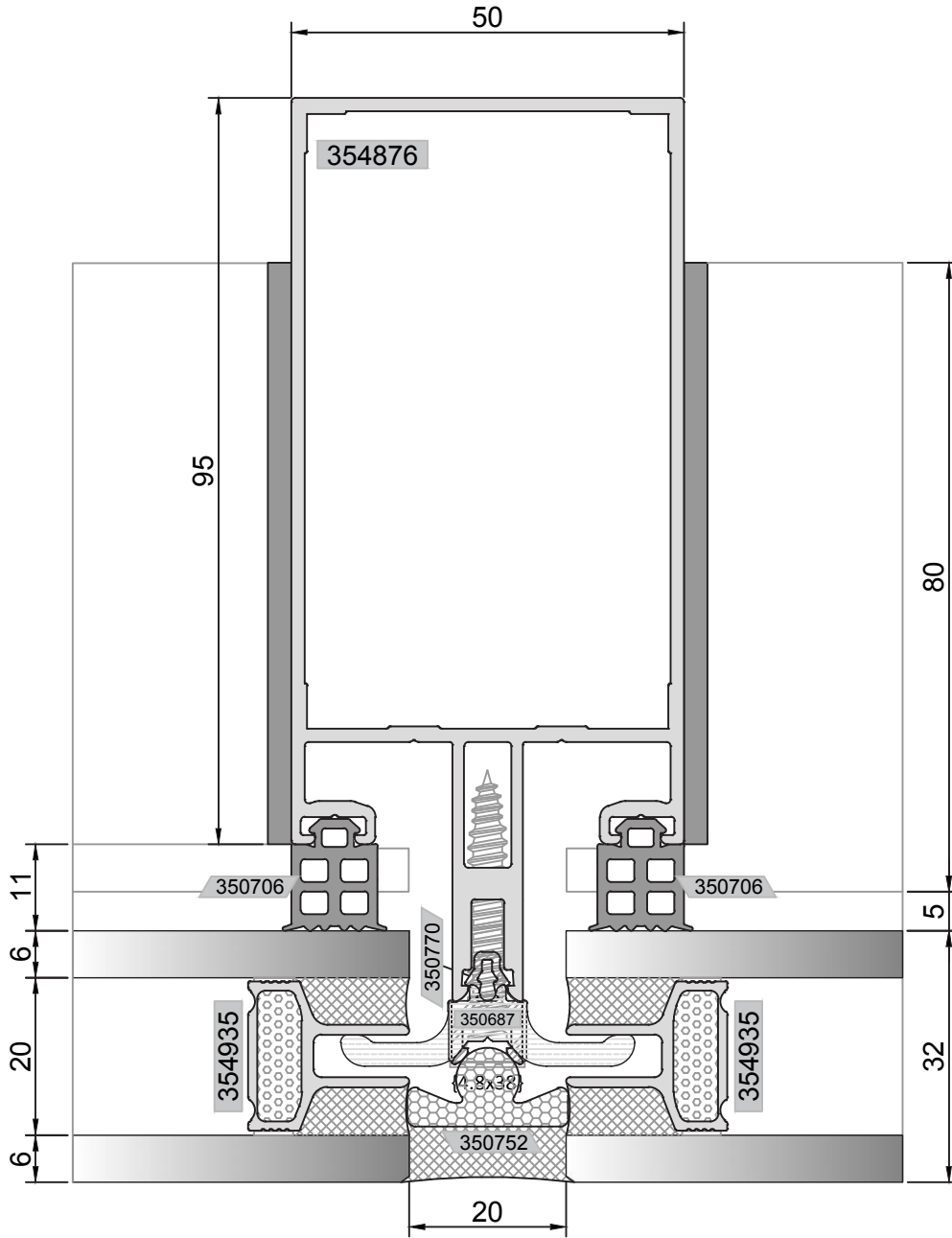

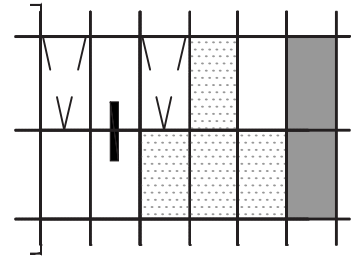

YATAY DETAYI  
HORIZONTAL DETAIL

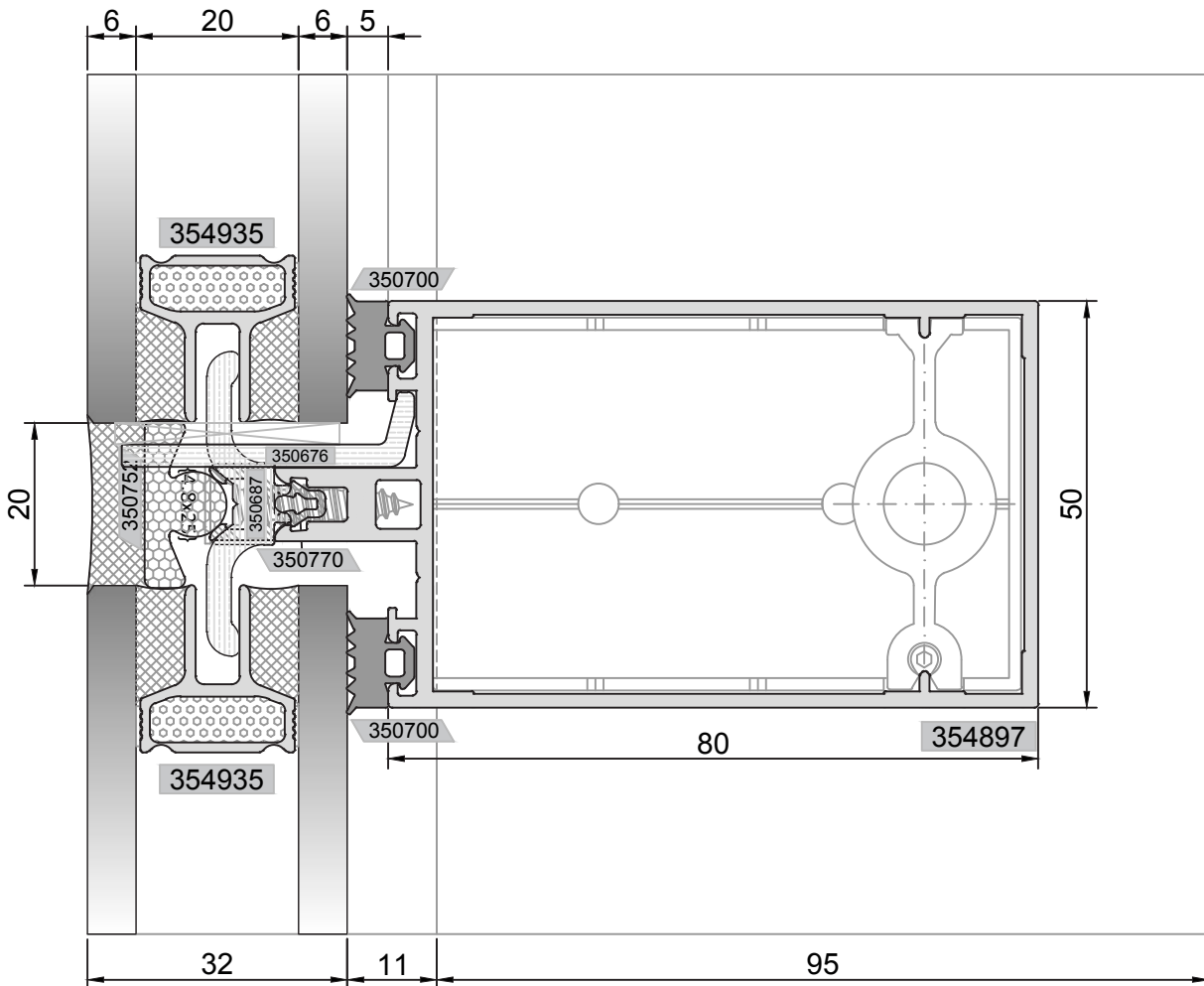

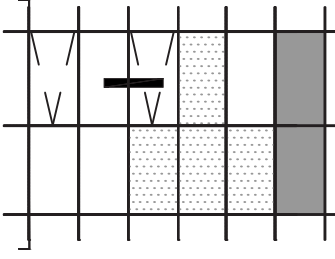

DÜŞEY DETAYI  
VERTICAL DETAIL

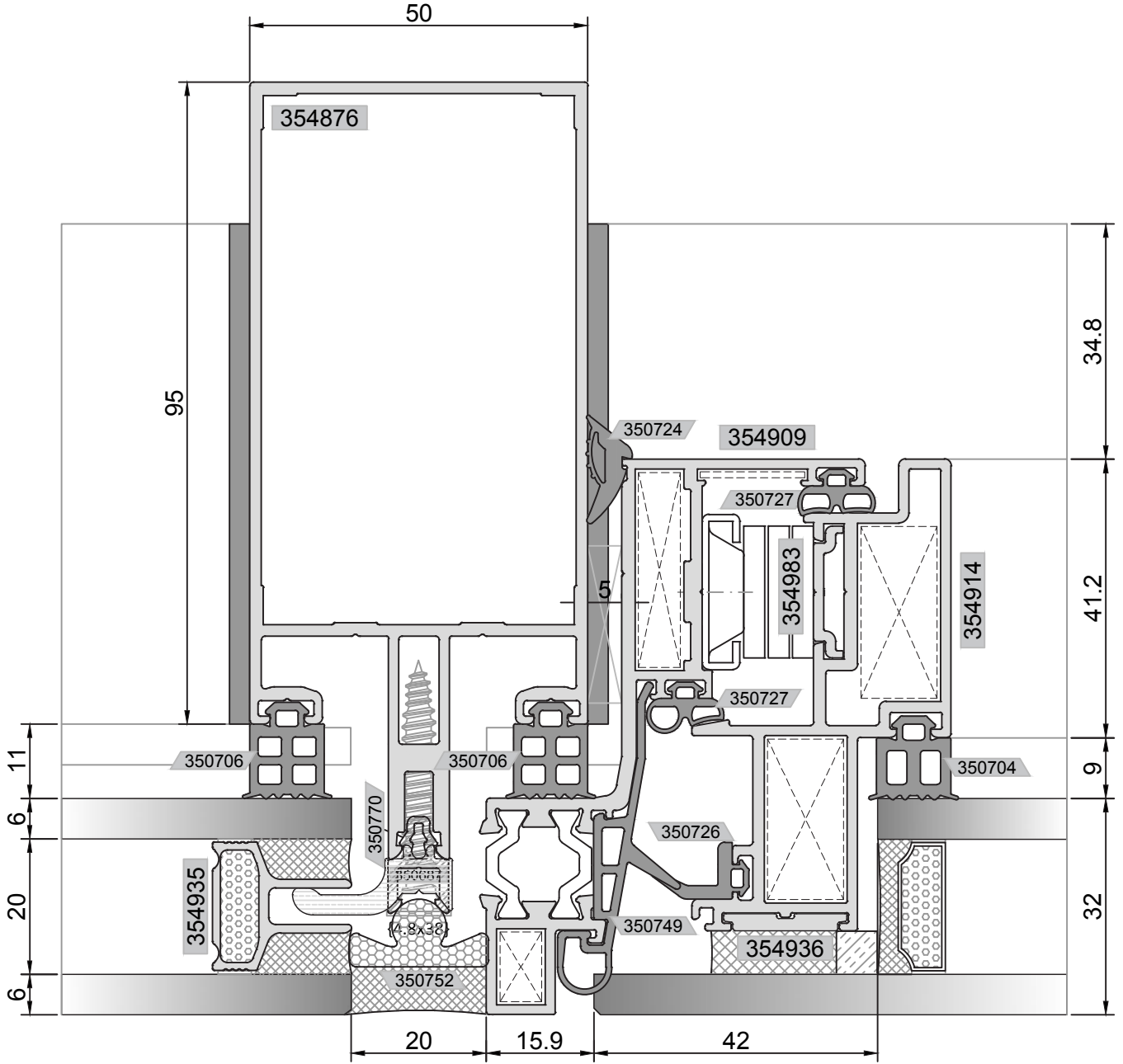

ALTERNATİF 1: YALITIMSIZ KANAT DETAYI  
ALTERNATIVE 1 : UNINSULATED VENT DETAIL

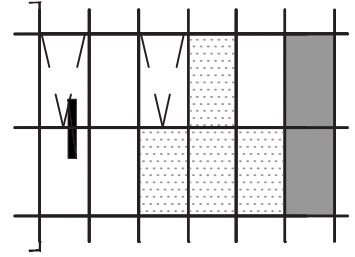

YATAY DETAYI  
HORIZONTAL DETAIL

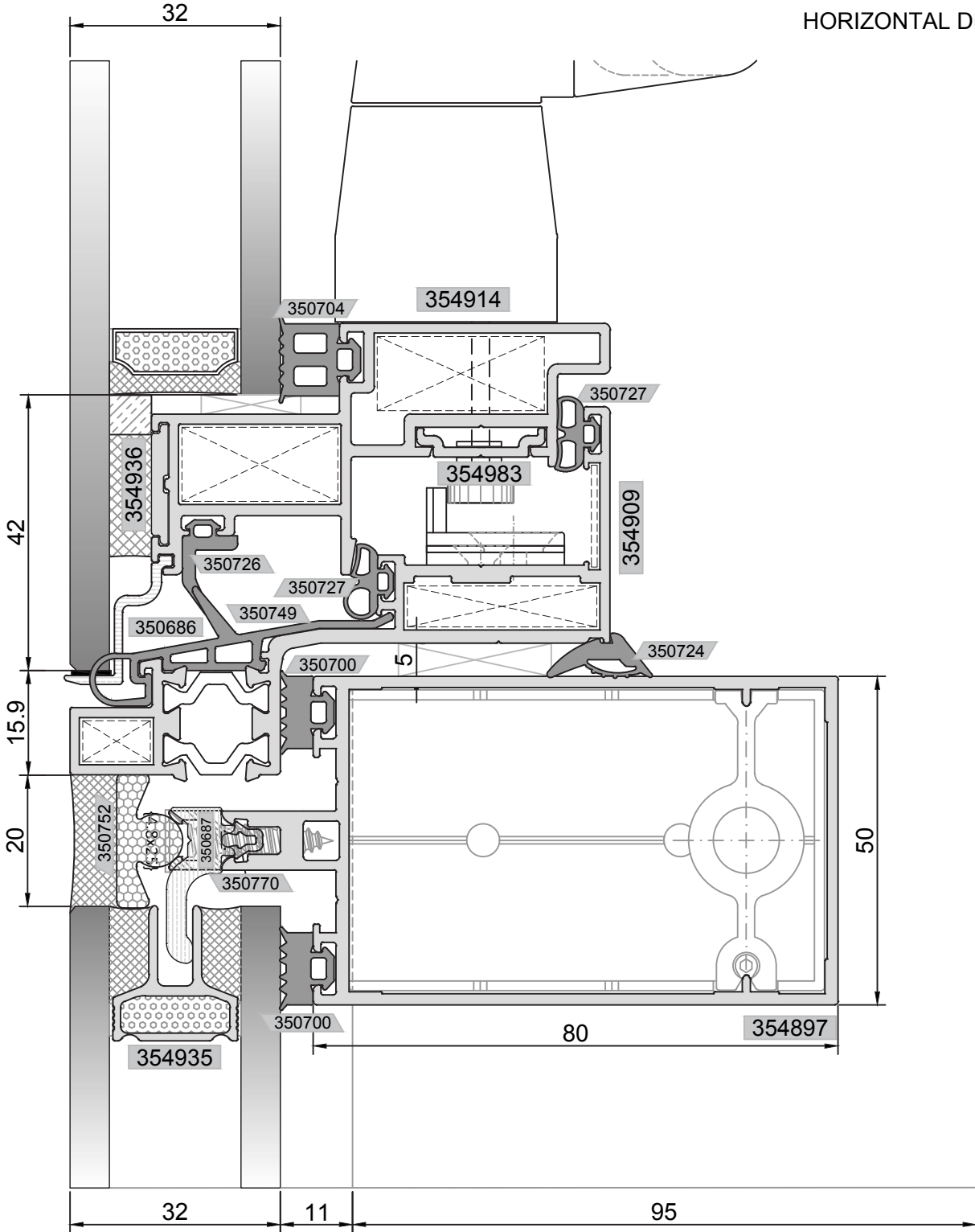

ALTERNATİF 1: YALITIMSIZ KANAT DETAYI  
ALTERNATIVE 1 : UNINSULATED VENT DETAIL

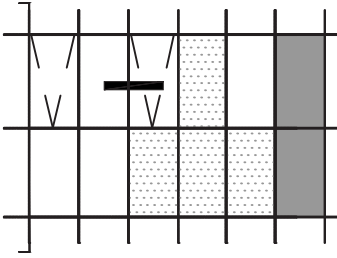

DÜŞEY DETAYI  
VERTICAL DETAIL

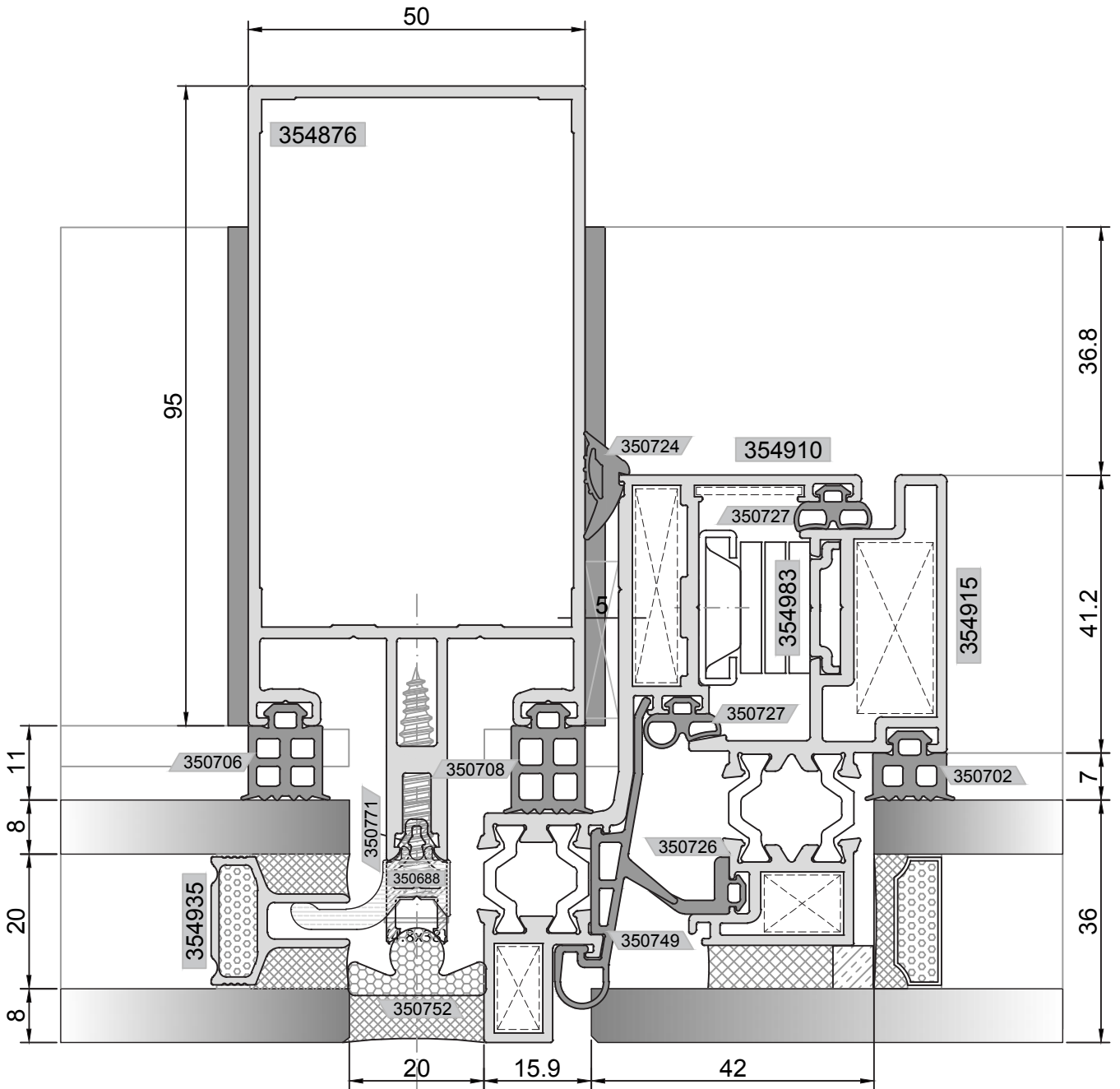

ALTERNATİF 2: YALITIMLI KANAT DETAYI  
ALTERNATIVE 2 : INSULATED VENT DETAIL

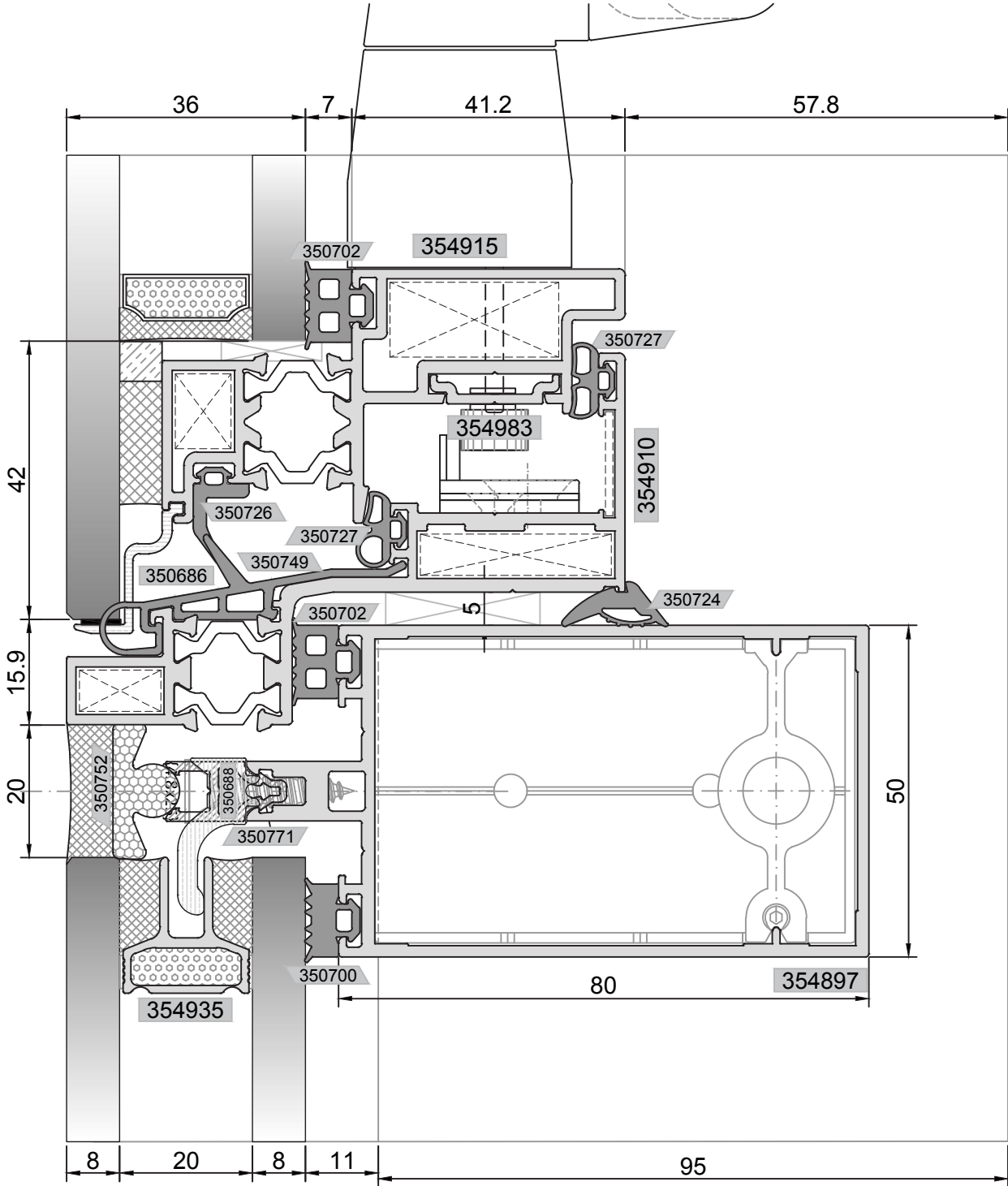
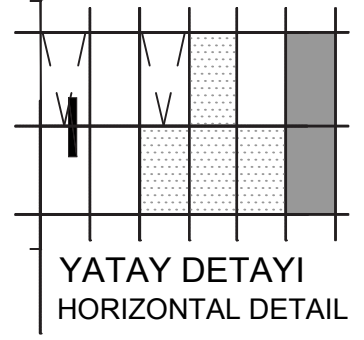

ALTERNATİF 2: YALITIMLI KANAT DETAYI  
ALTERNATIVE 2 : INSULATED VENT DETAIL

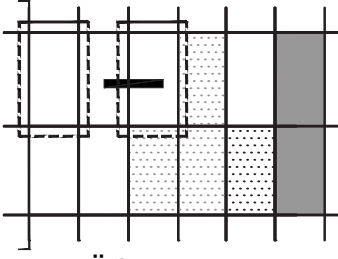

DÜŞEY DETAYI  
VERTICAL DETAIL

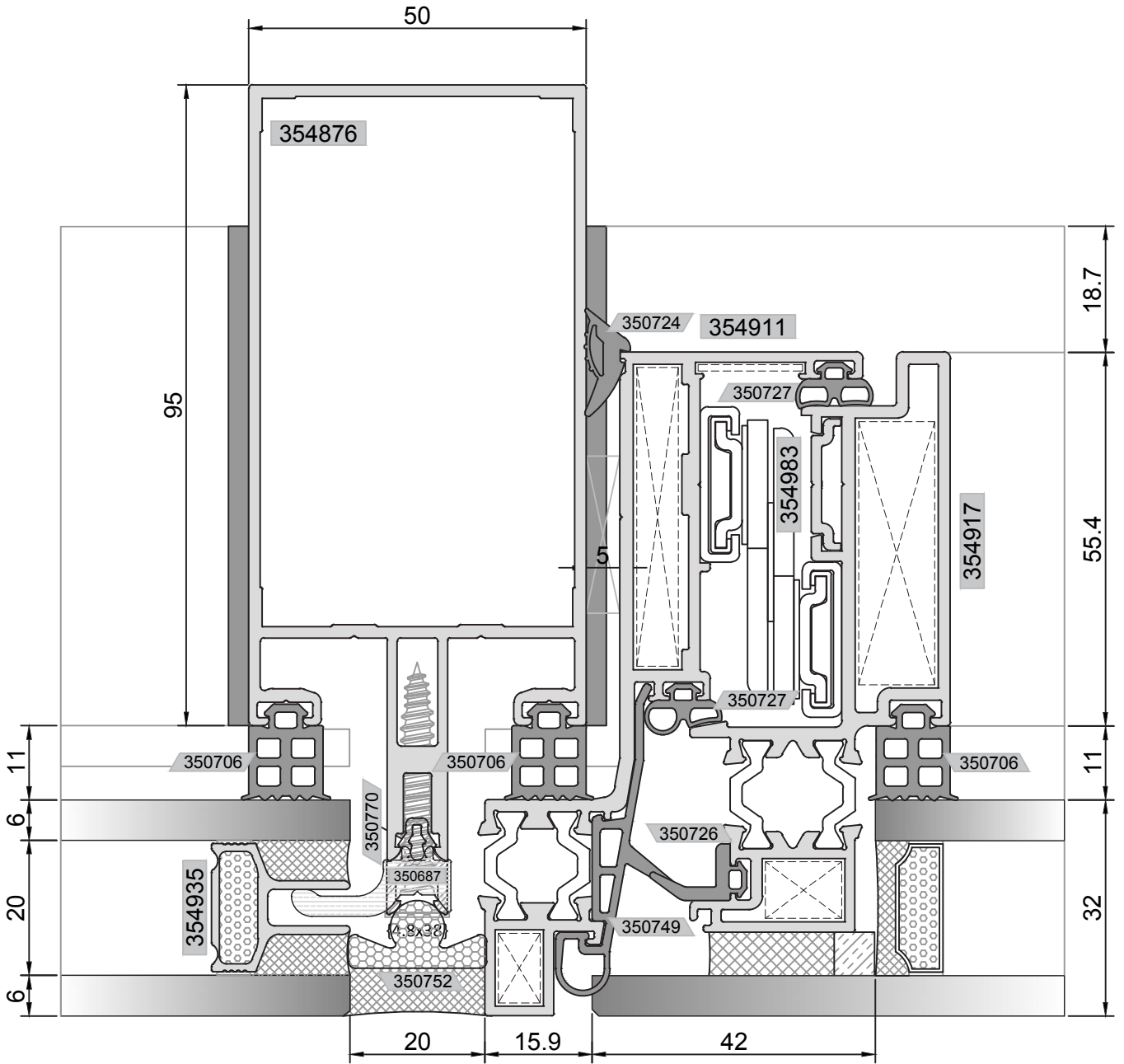

ALTERNATİF 1: YALITIMLI PARALEL AÇILIR KANAT DETAYI  
ALTERNATIVE 1 : PARALEL OPENING INSULATED VENT DETAIL

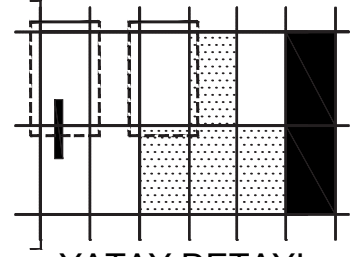

YATAY DETAYI  
HORIZONTAL DETAIL

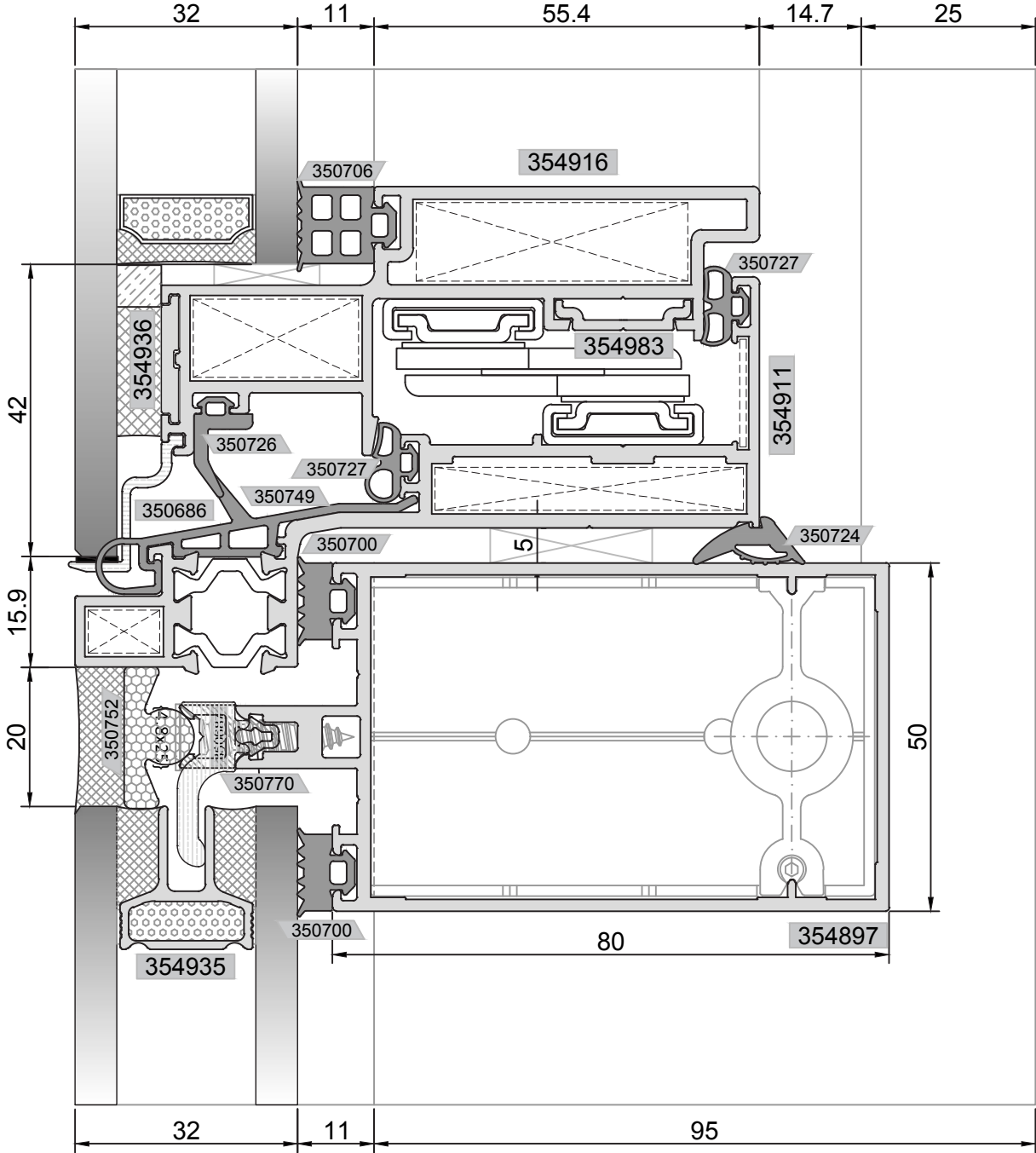

ALTERNATİF 2: YALITIMSIZ PARALEL AÇILIR KANAT DETAYI  
ALTERNATIVE 2 : PARALEL OPENING UNINSULATED VENT DETAIL



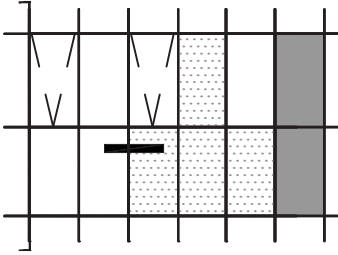

DÜŞEY DETAYI  
VERTICAL DETAIL

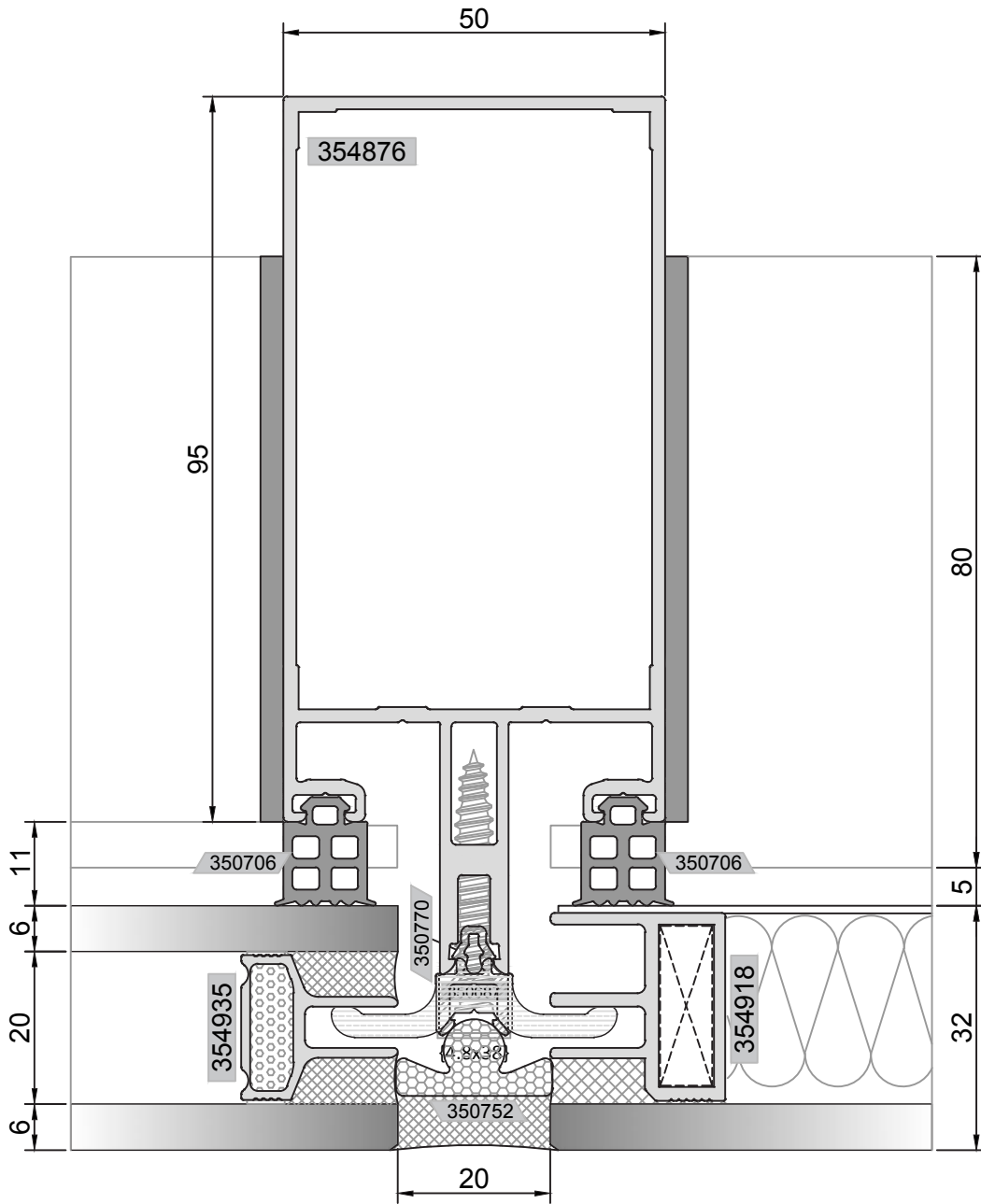

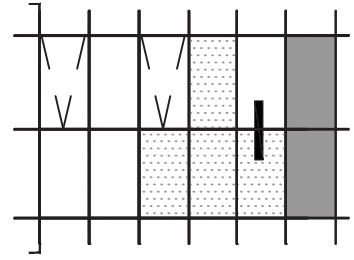

YATAY DETAYI  
HORIZONTAL DETAIL

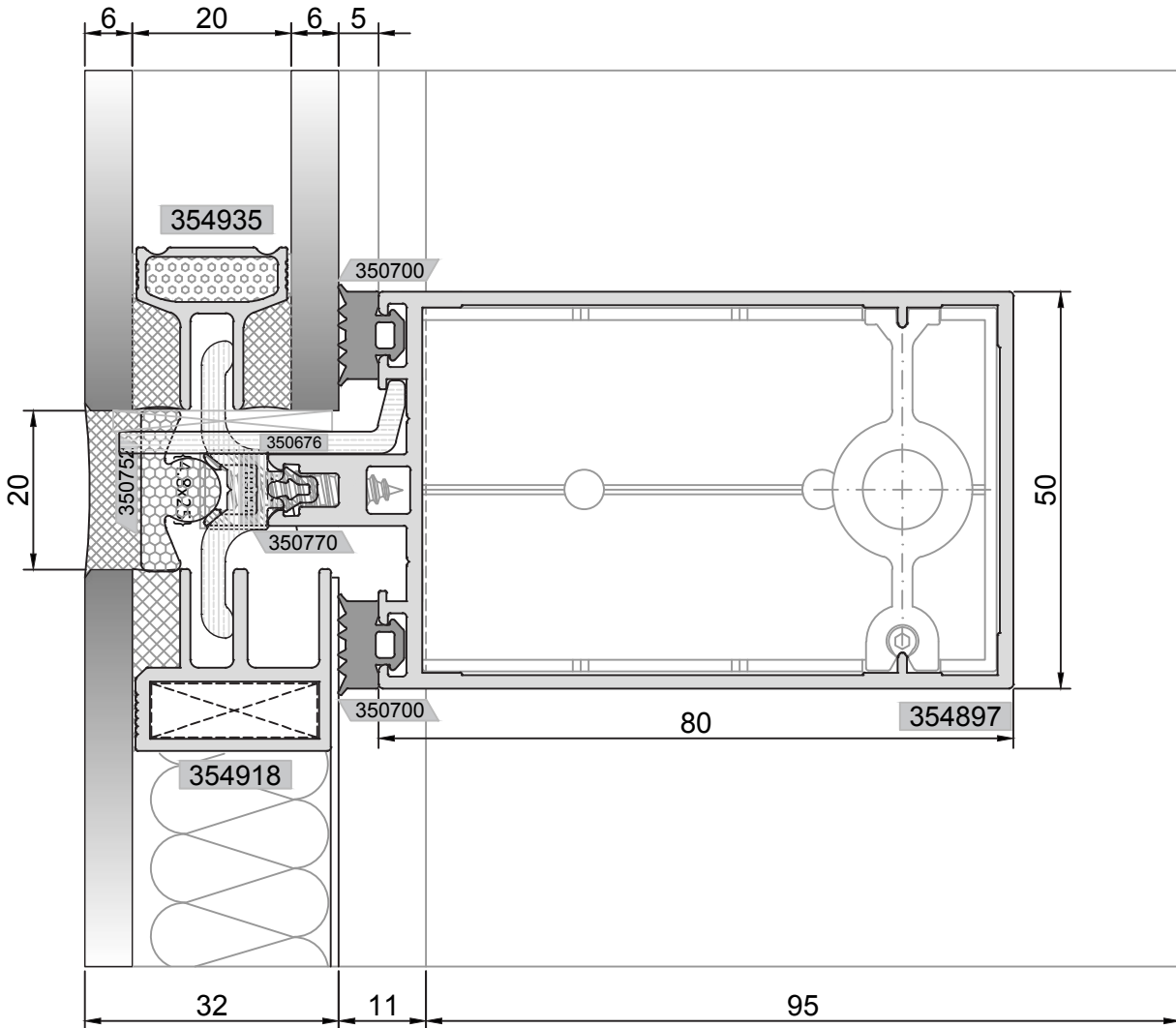

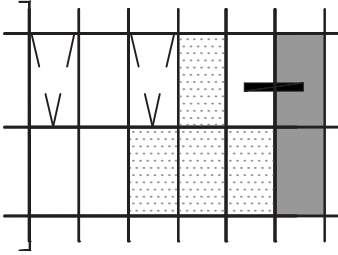

DÜŞEY DETAYI  
VERTICAL DETAIL

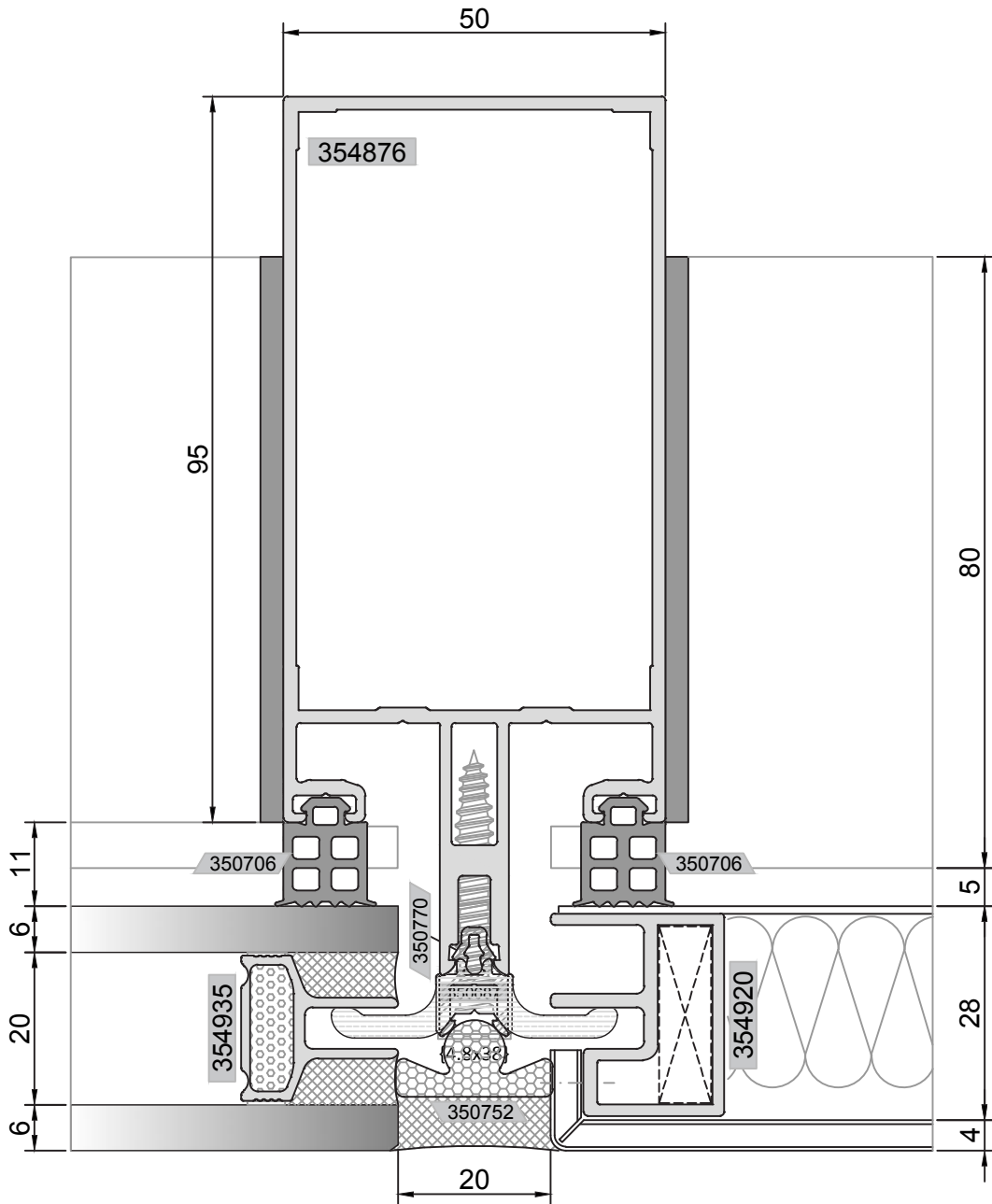

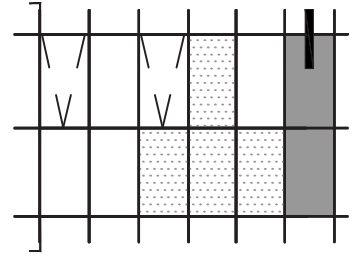

YATAY DETAYI  
HORIZONTAL DETAIL

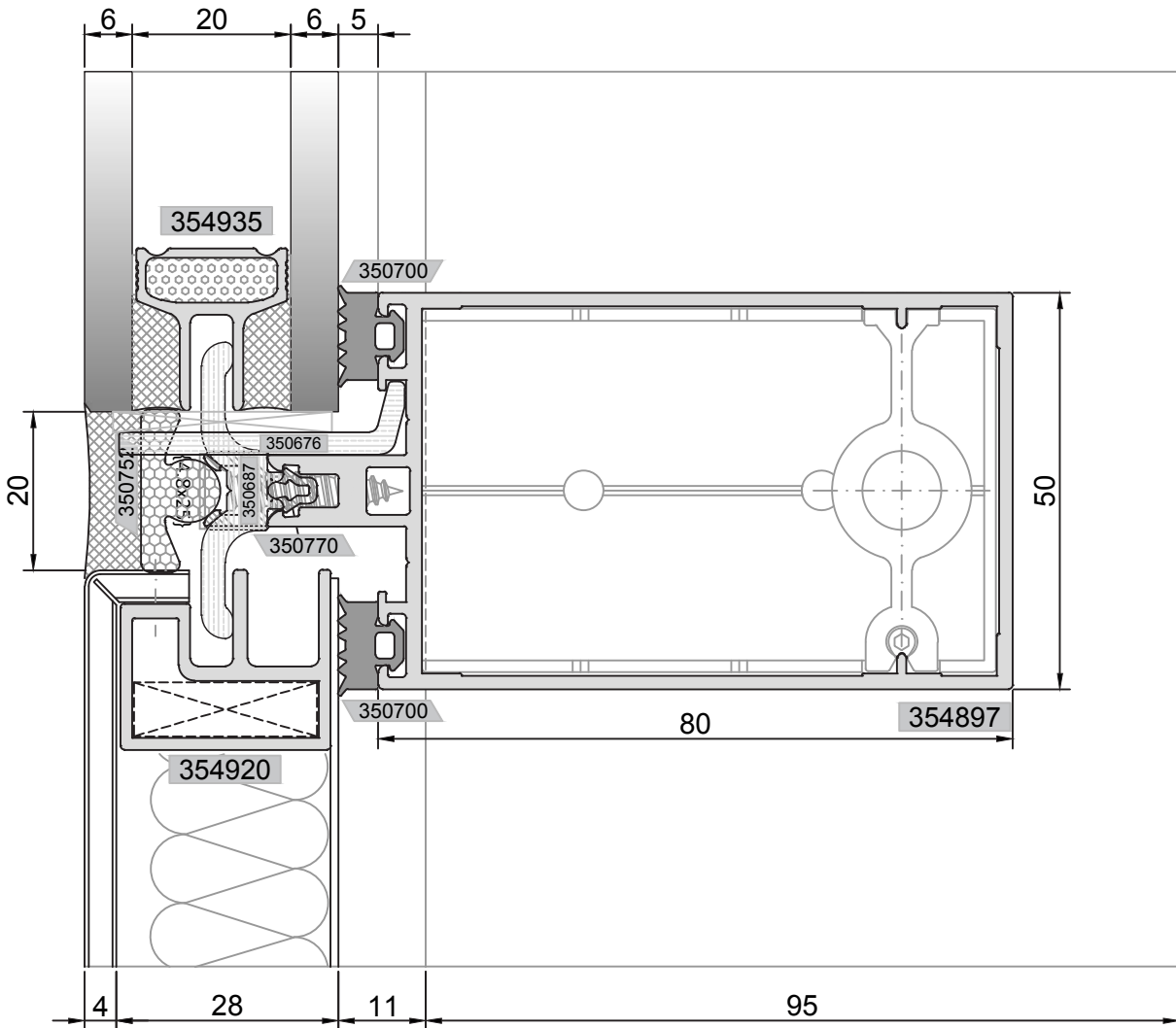

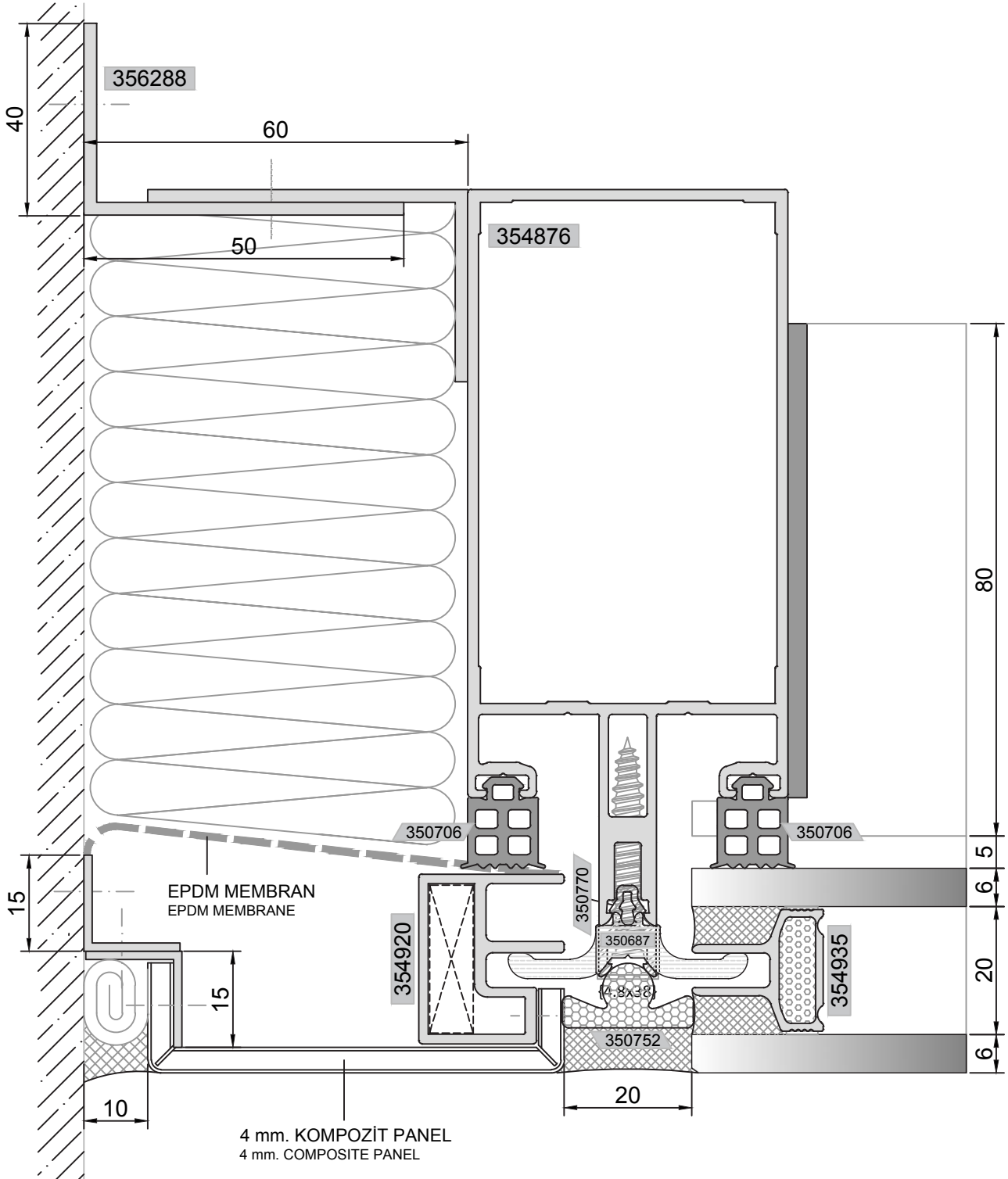
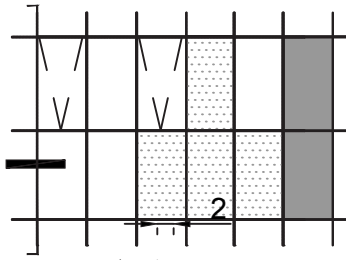

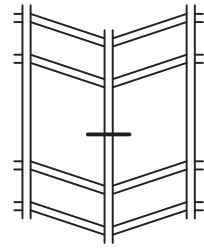

0° - 10°

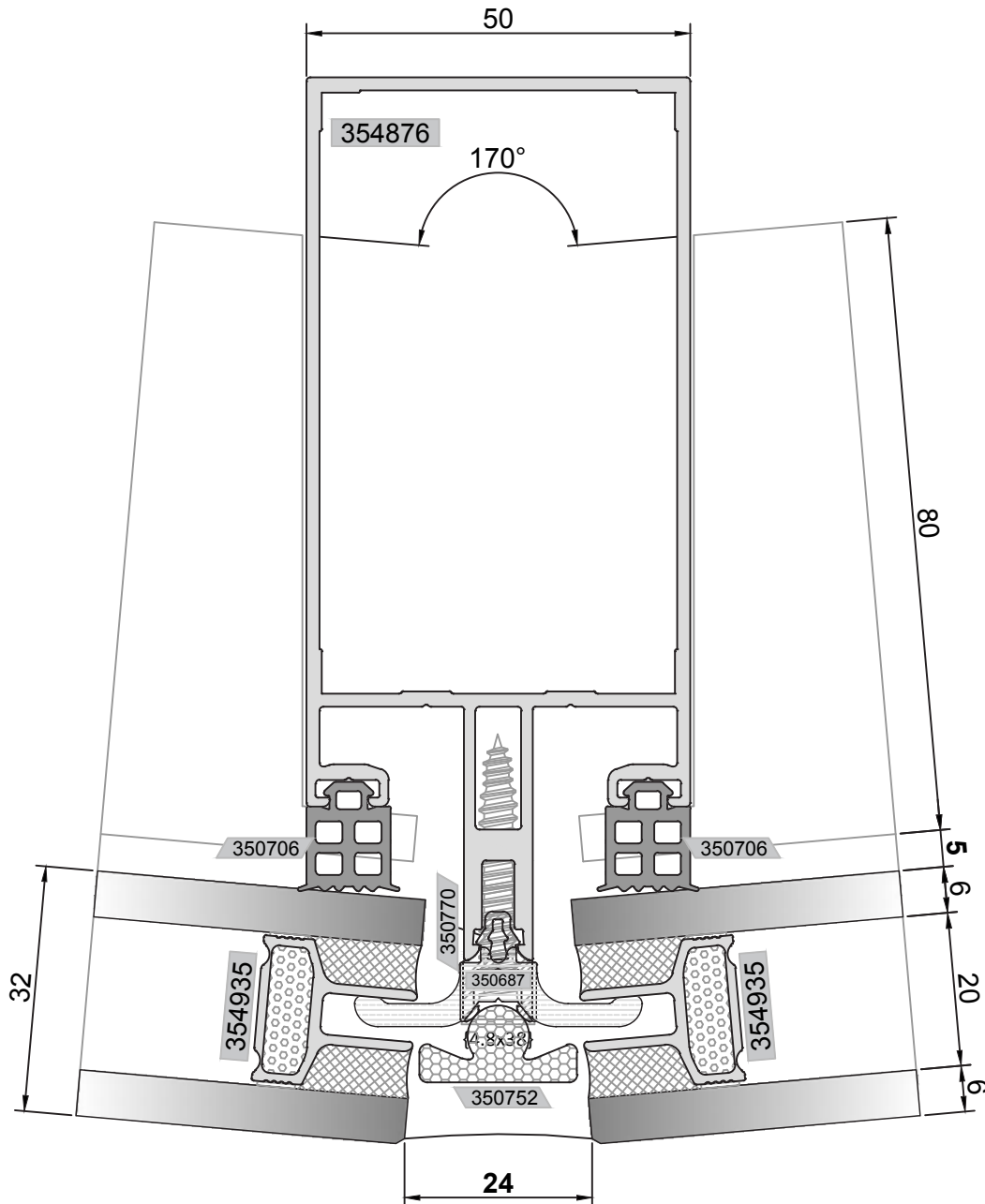

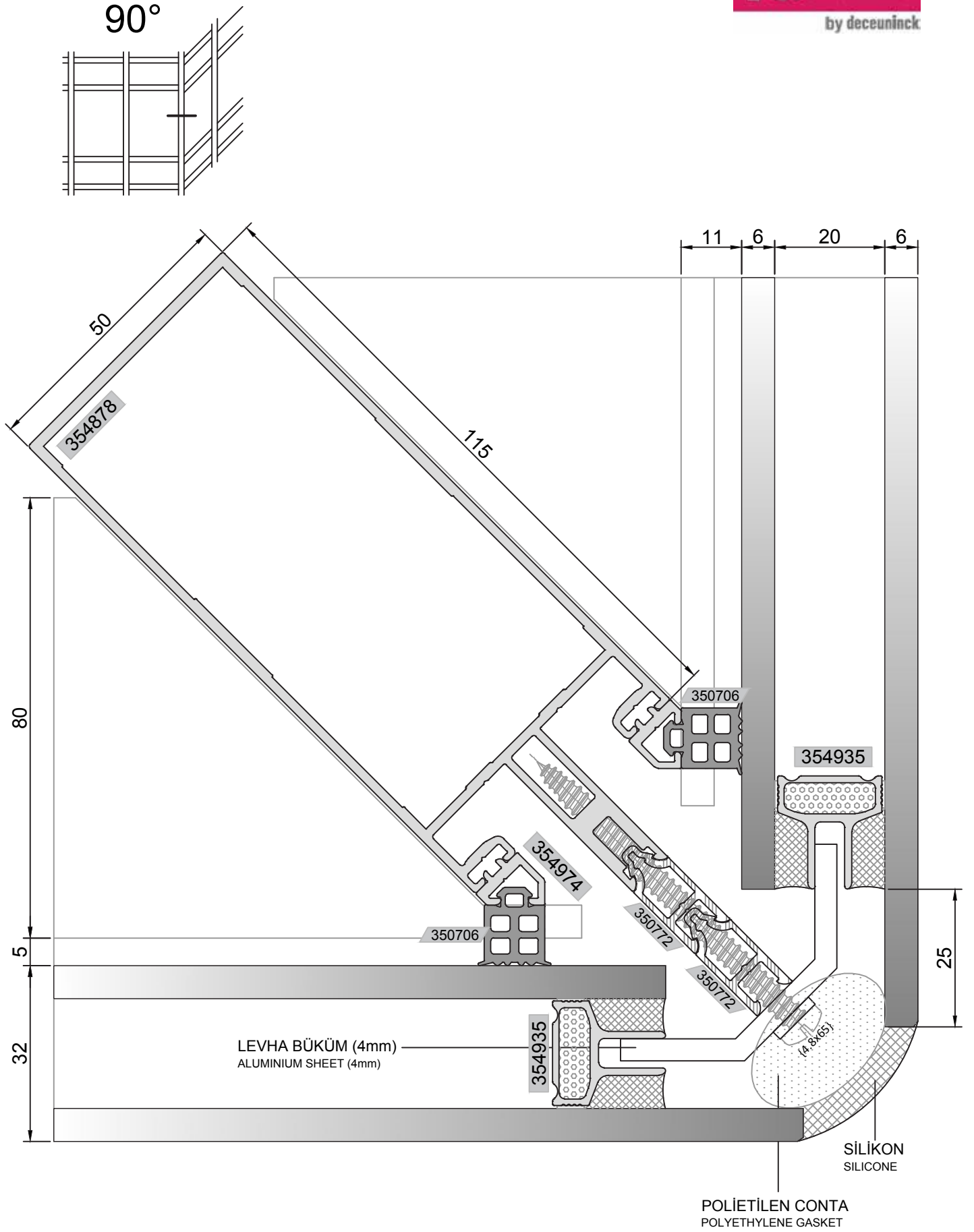

ALTERNATİF 1: TEK DİKMELİ KÖŞE DETAYI  
ALTERNATIVE 1 : CORNER DETAIL WITH SINGLE MULLION

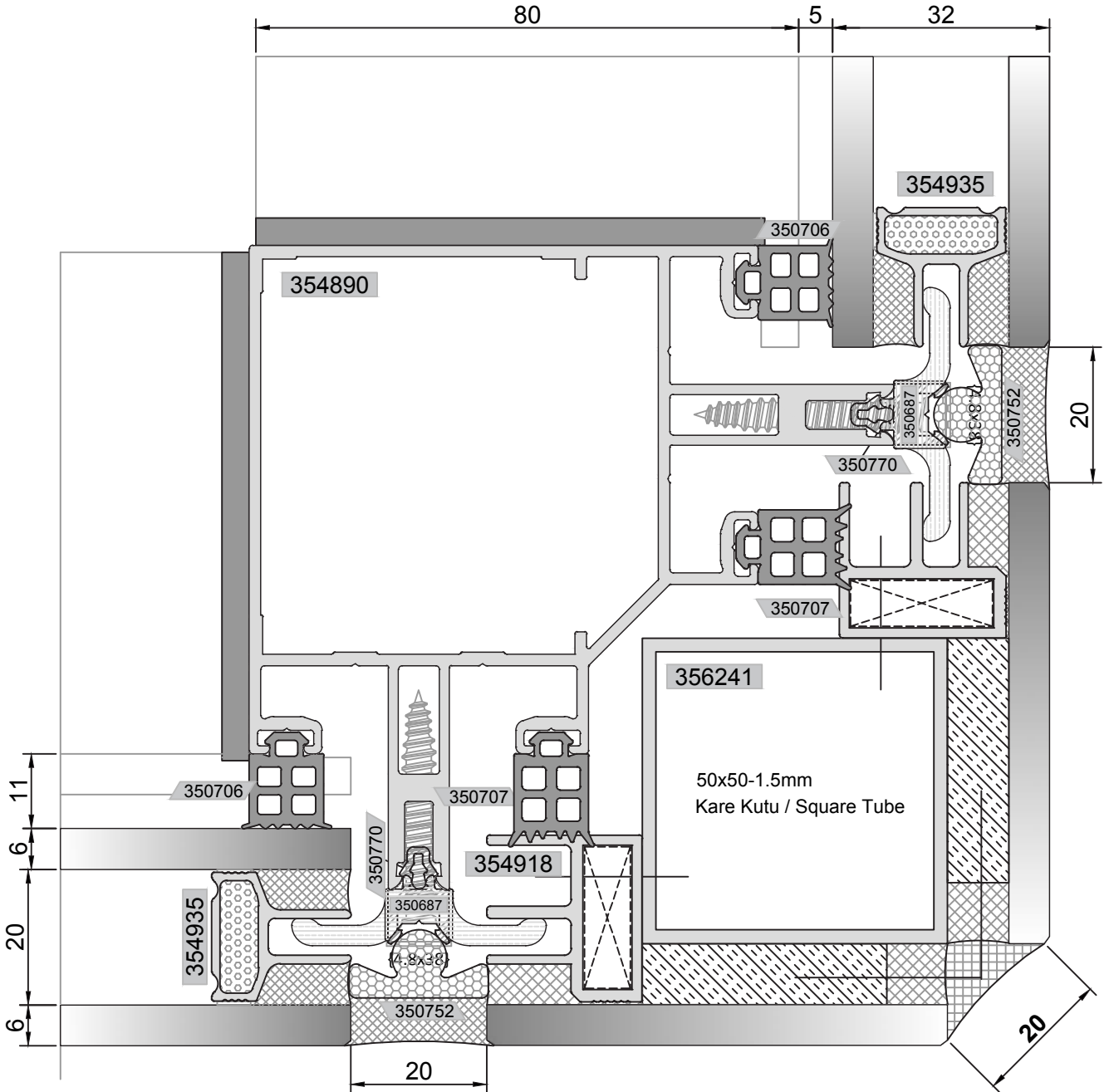
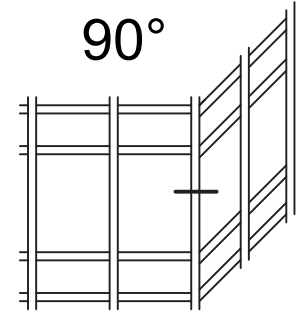

ALTERNATİF 2: ÇİFT DİKMELİ KÖŞE DETAYI  
ALTERNATIVE 2 : CORNER DETAIL WITH DOUBLE MULLION



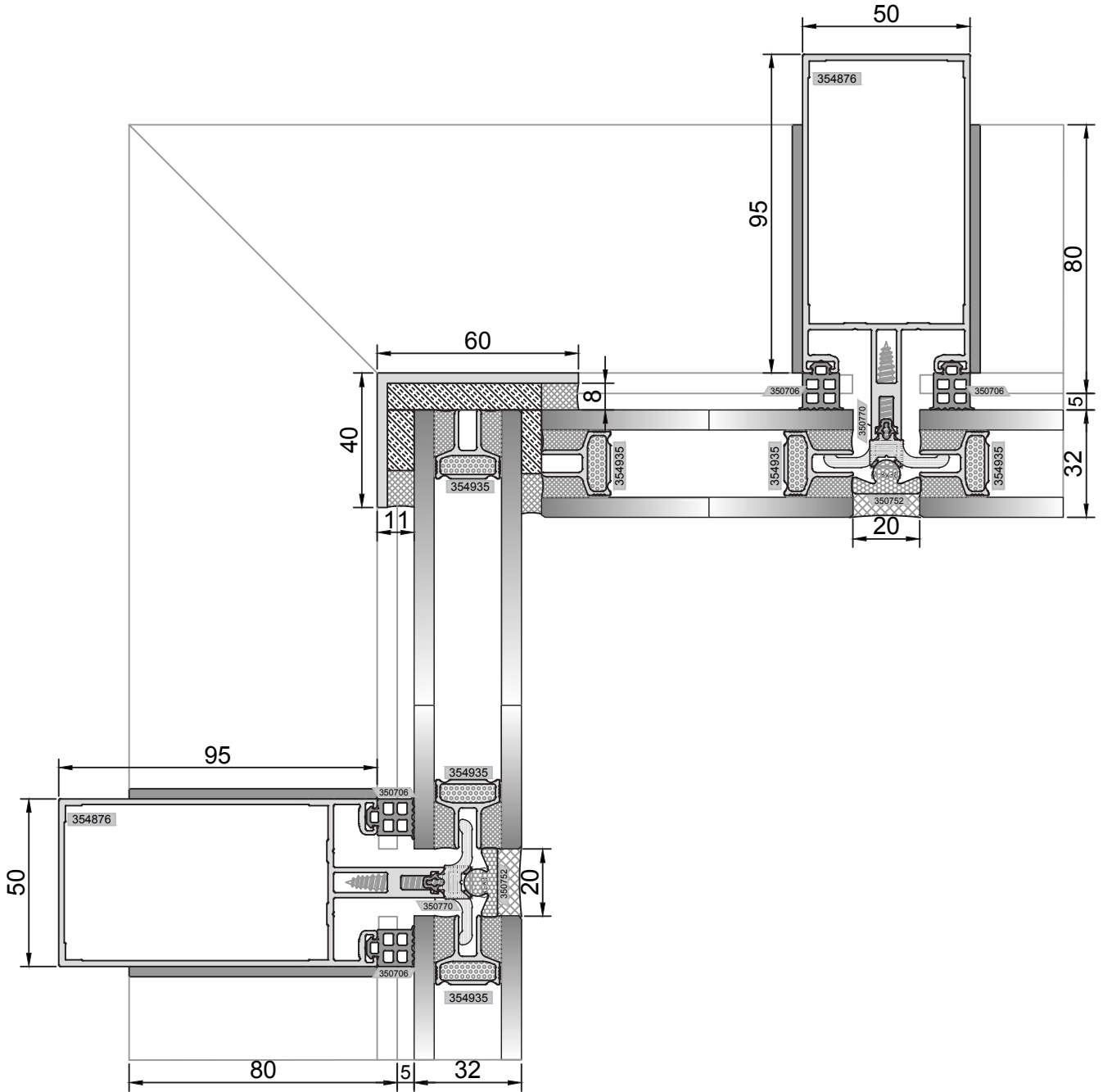
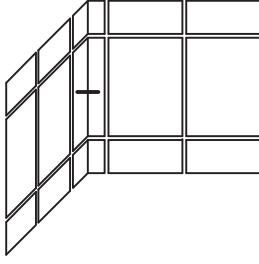

90° İÇ AÇILI CAM CEPHE DÜŞEY KESİT DETAYI  
FOUR SIDE WITH 90° INTERNAL ANGLE VERTICAL DETAIL

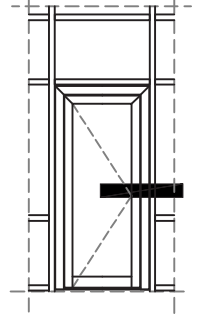
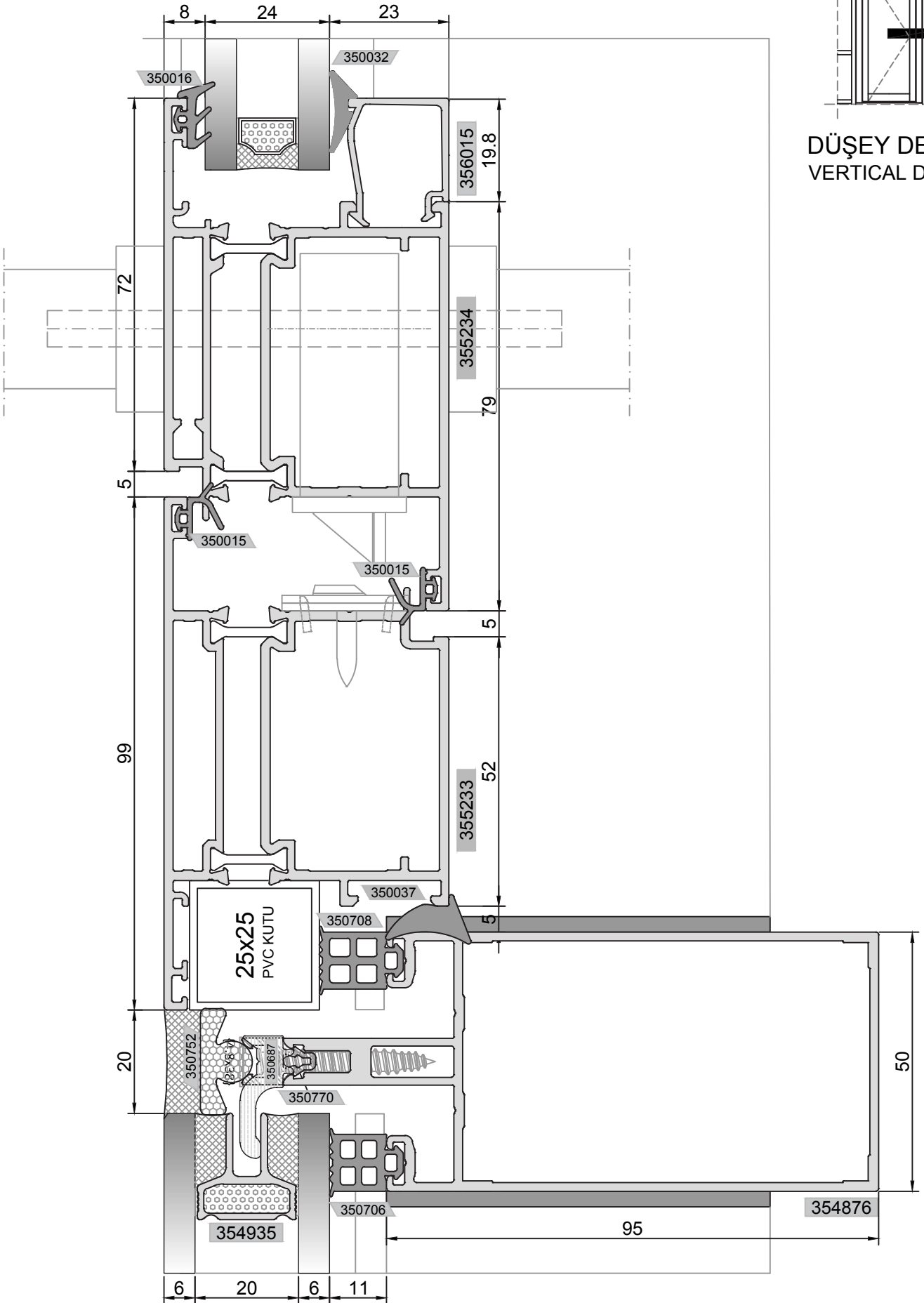

DÜŞEY DETAYI  
VERTICAL DETAIL

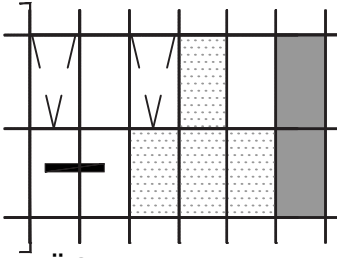

DÜŞEY DETAYI  
VERTICAL DETAIL

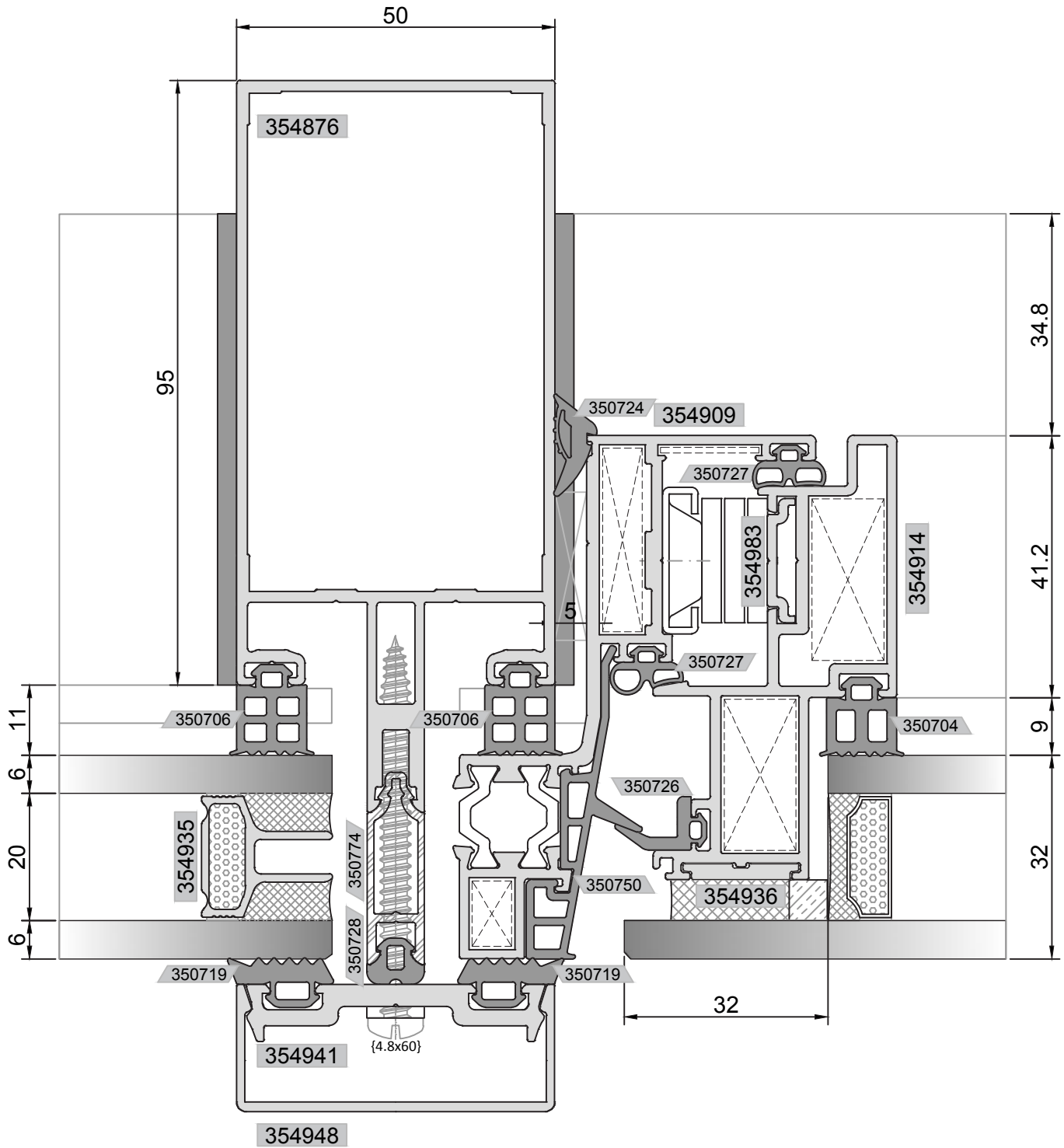

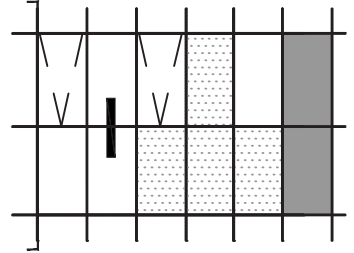

YATAY DETAYI  
HORIZONTAL DETAIL

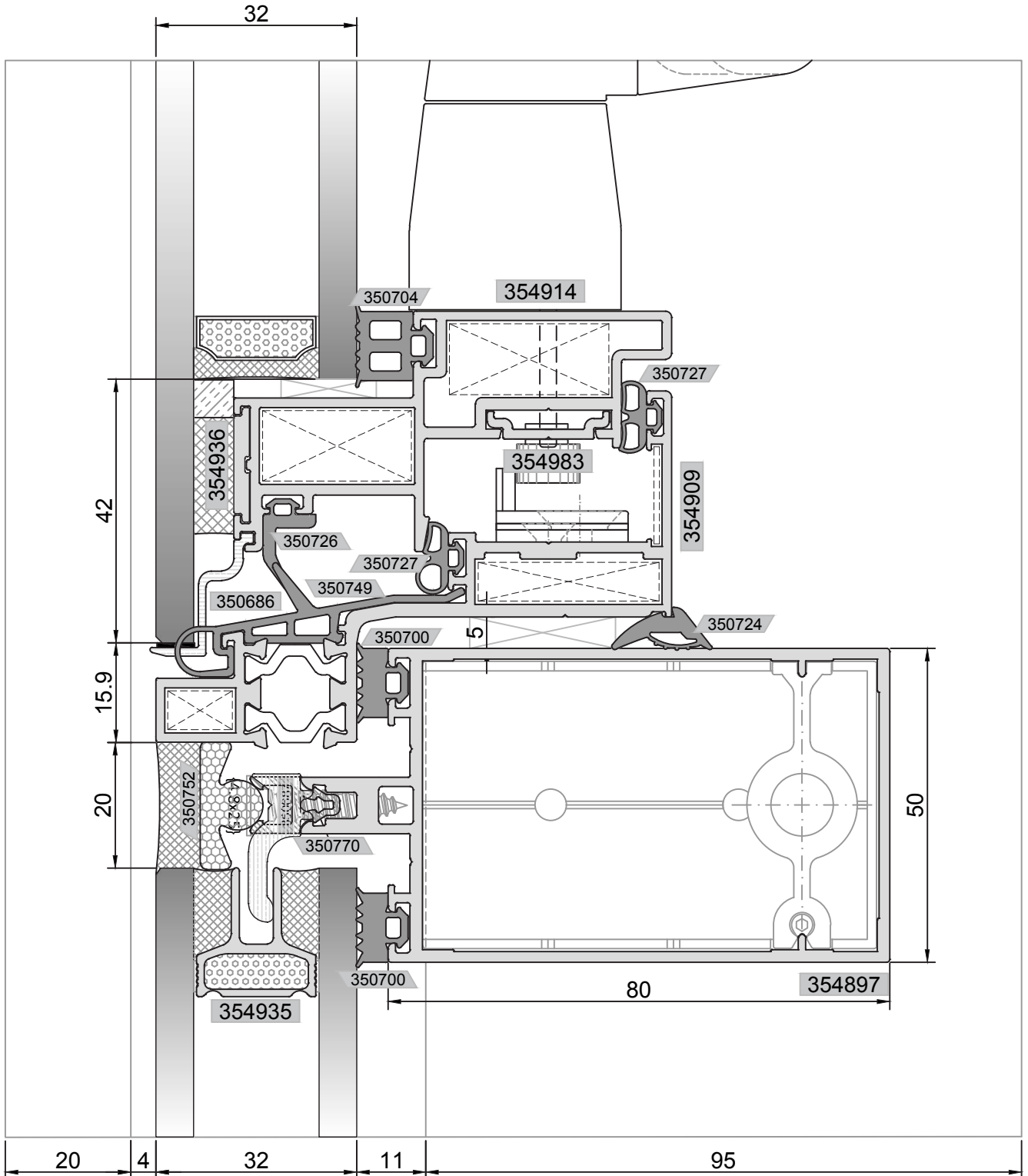

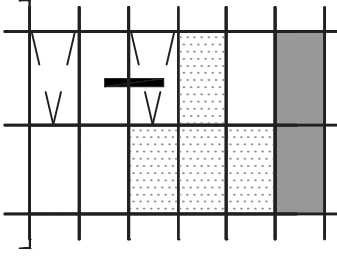

DÜŞEY DETAYI  
VERTICAL DETAIL

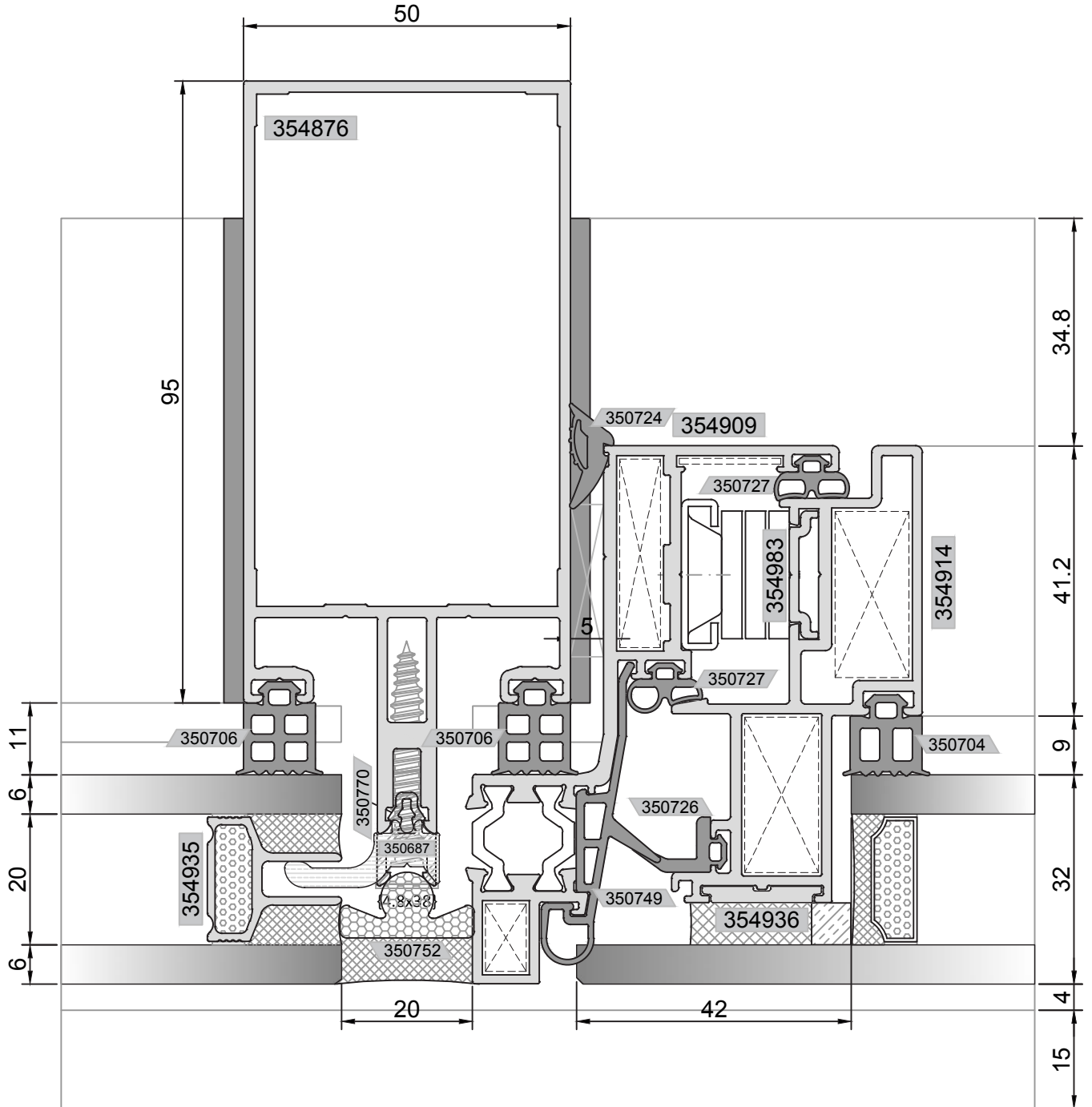

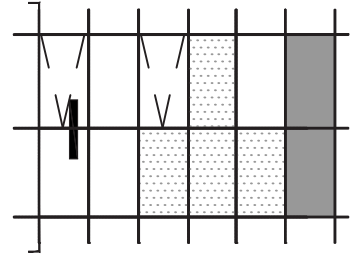

YATAY DETAYI  
HORIZONTAL DETAIL

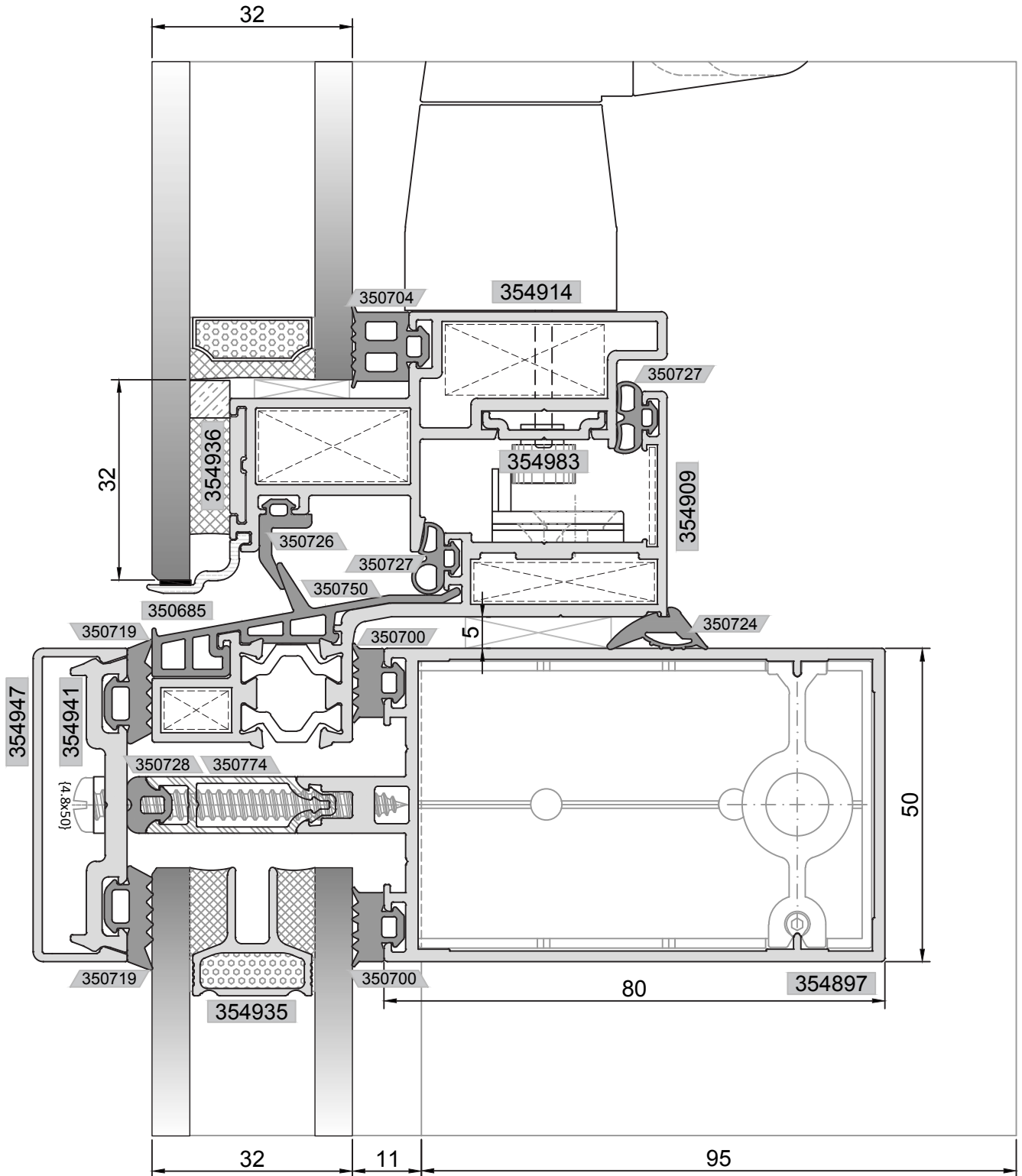

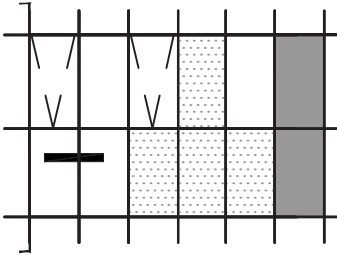

DÜŞEY DETAYI  
VERTICAL DETAIL

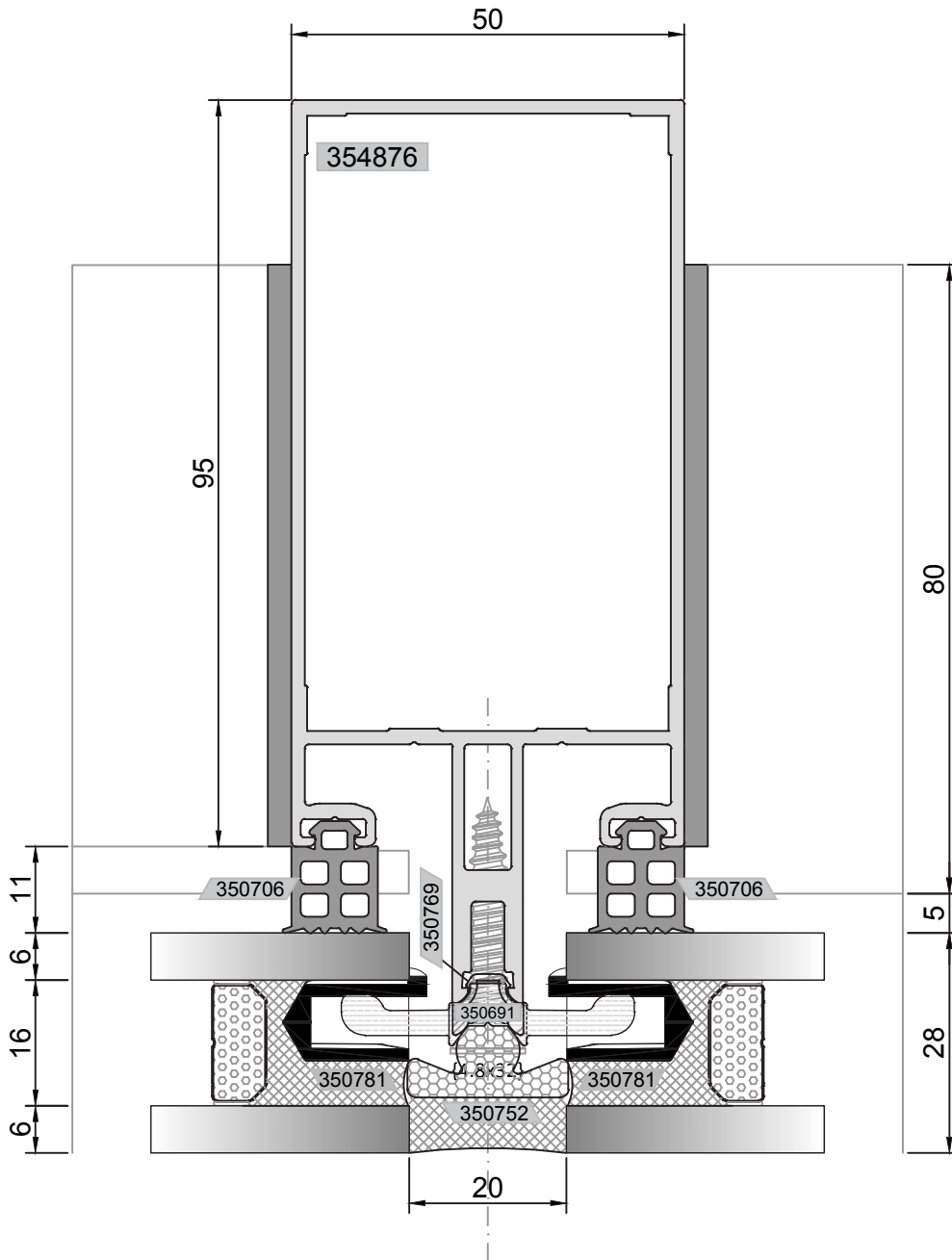

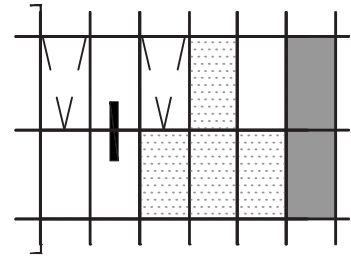

YATAY DETAYI  
HORIZONTAL DETAIL

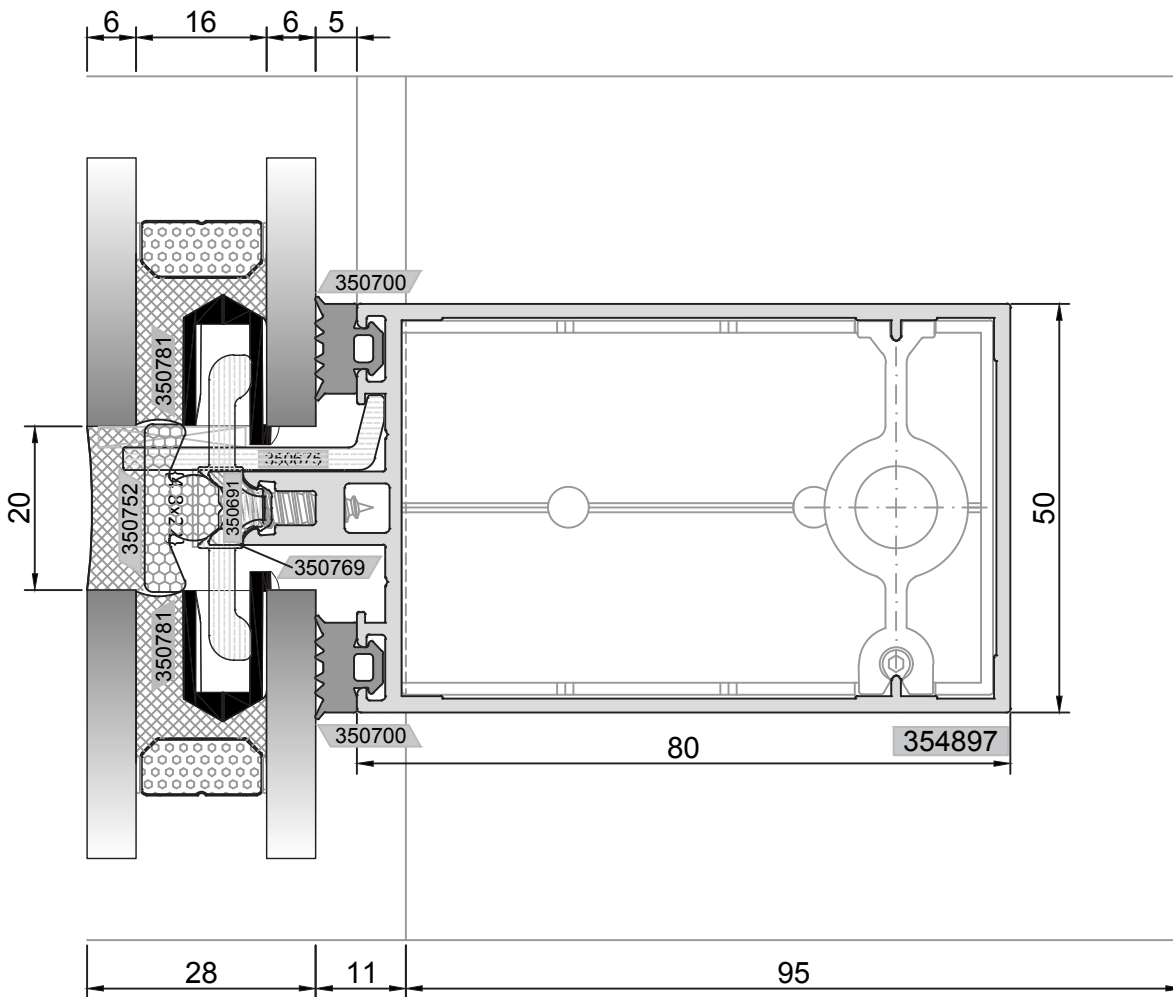



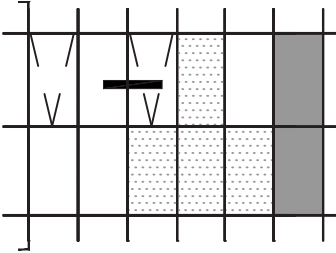

DÜŞEY DETAYI  
VERTICAL DETAIL

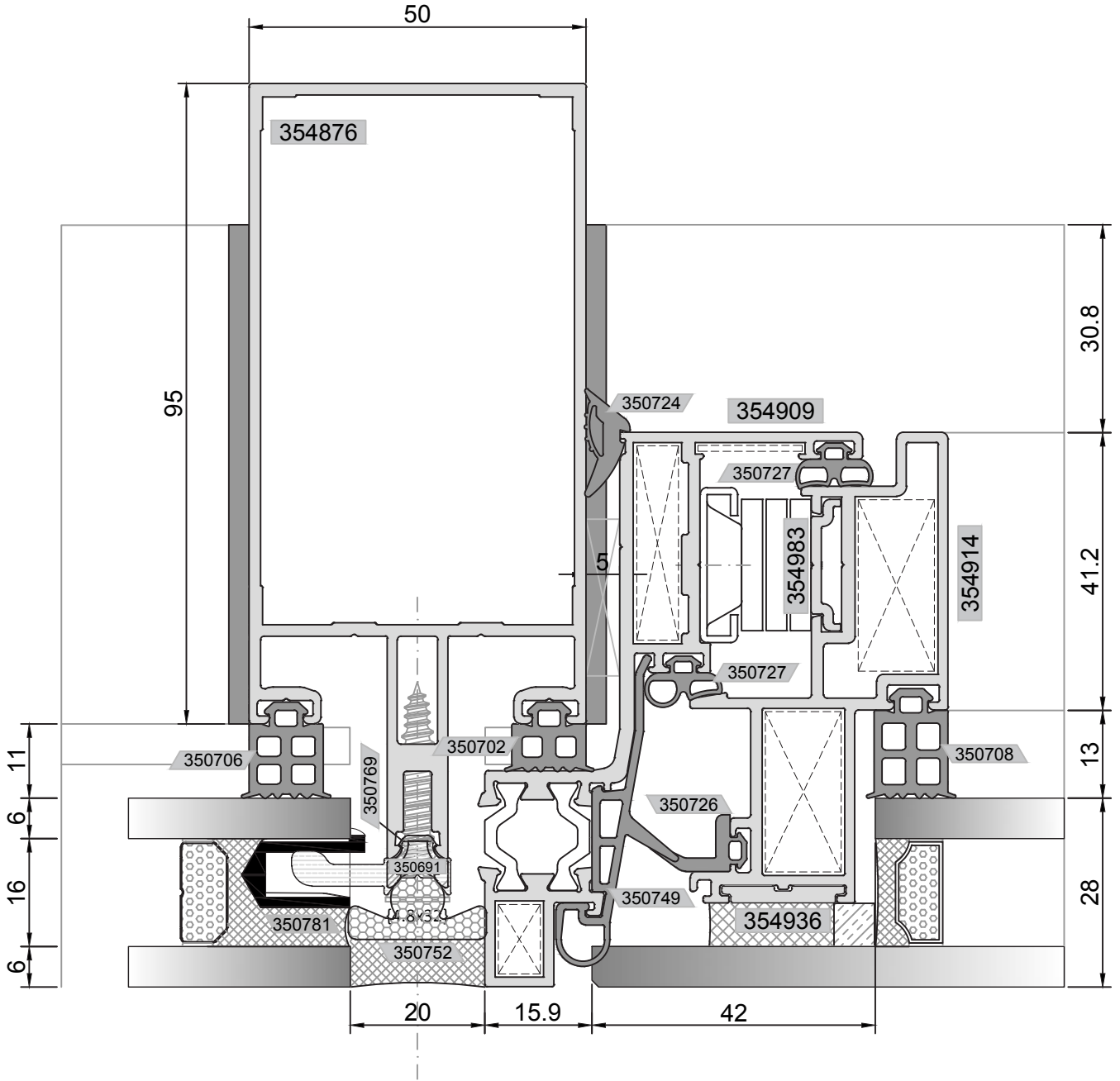

ALTERNATİF 1: YALITIMSIZ KANAT DETAYI  
ALTERNATIVE 1 : UNINSULATED VENT DETAIL

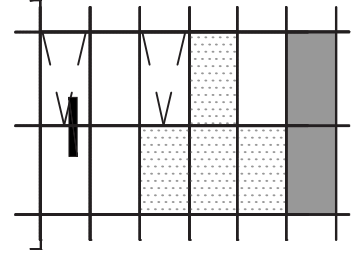

YATAY DETAYI  
HORIZONTAL DETAIL

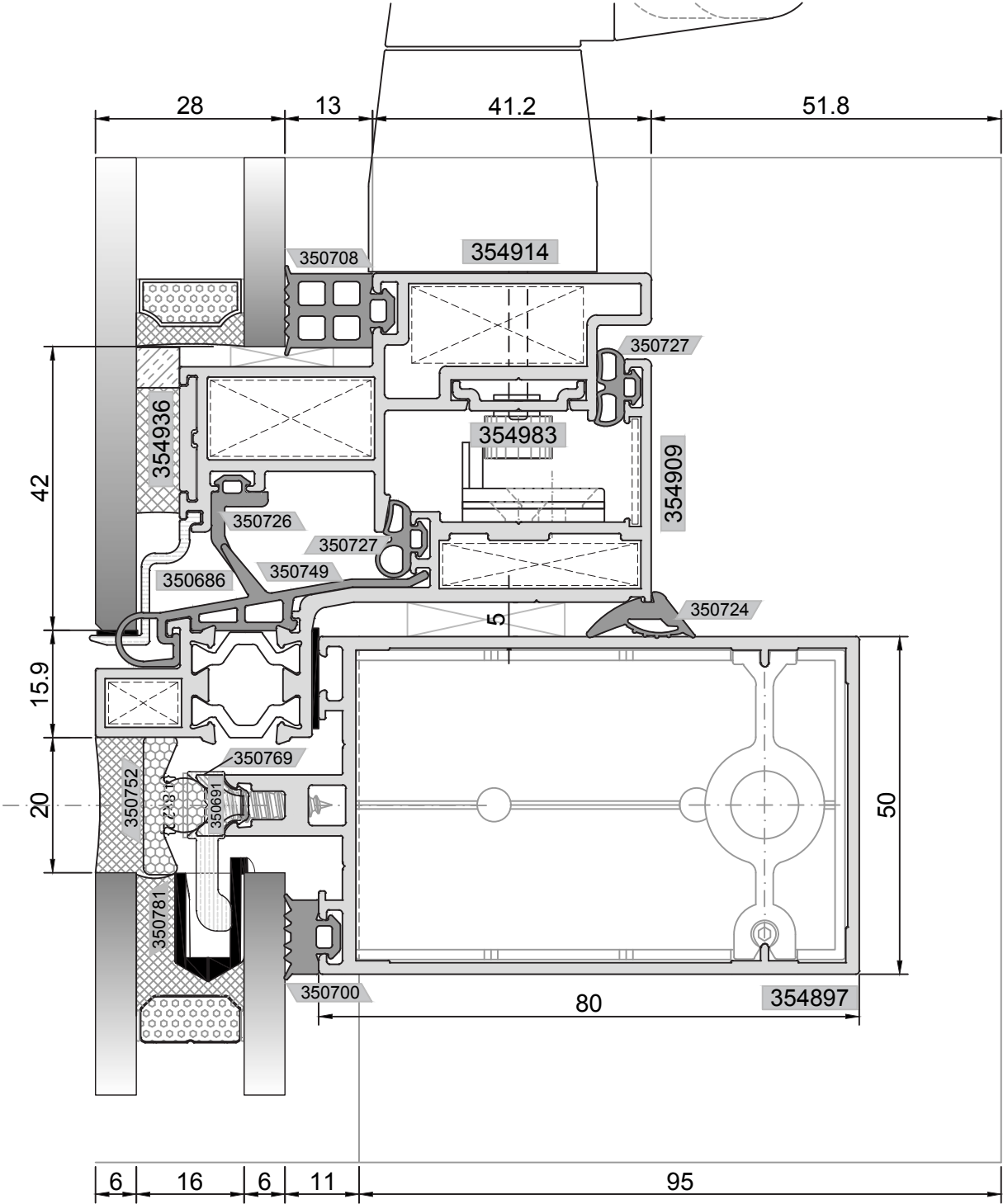

ALTERNATİF 1: YALITIMSIZ KANAT DETAYI  
ALTERNATIVE 1 : UNINSULATED VENT DETAIL

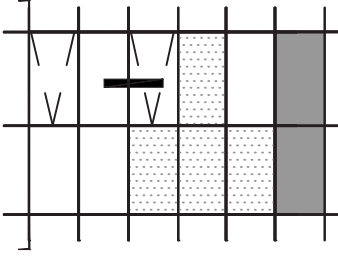

DÜŞEY DETAYI  
VERTICAL DETAIL

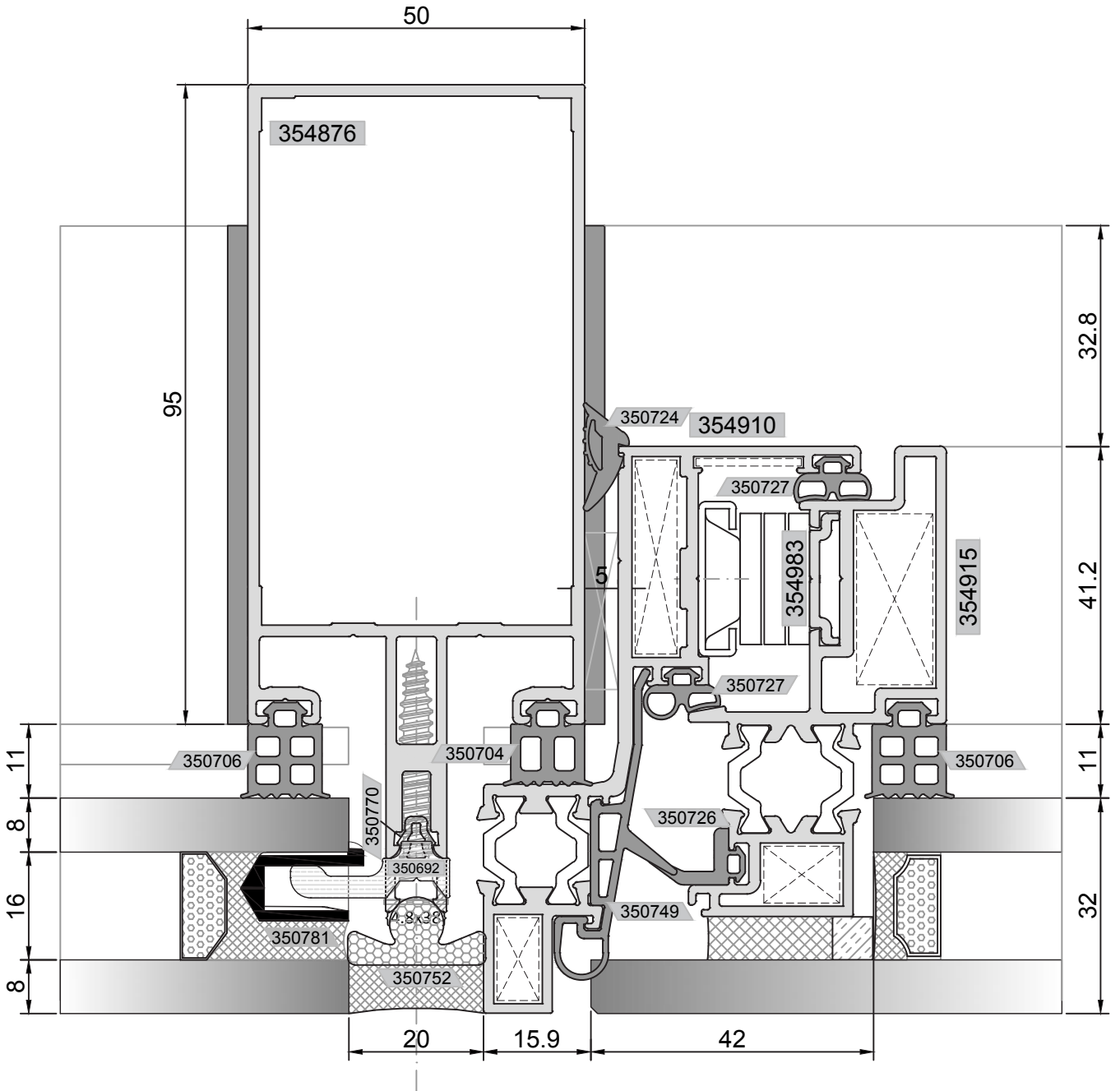

ALTERNATİF 2: YALITIMLI KANAT DETAYI  
ALTERNATIVE 2 : INSULATED VENT DETAIL

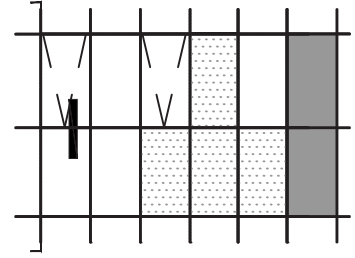

YATAY DETAYI  
HORIZONTAL DETAIL

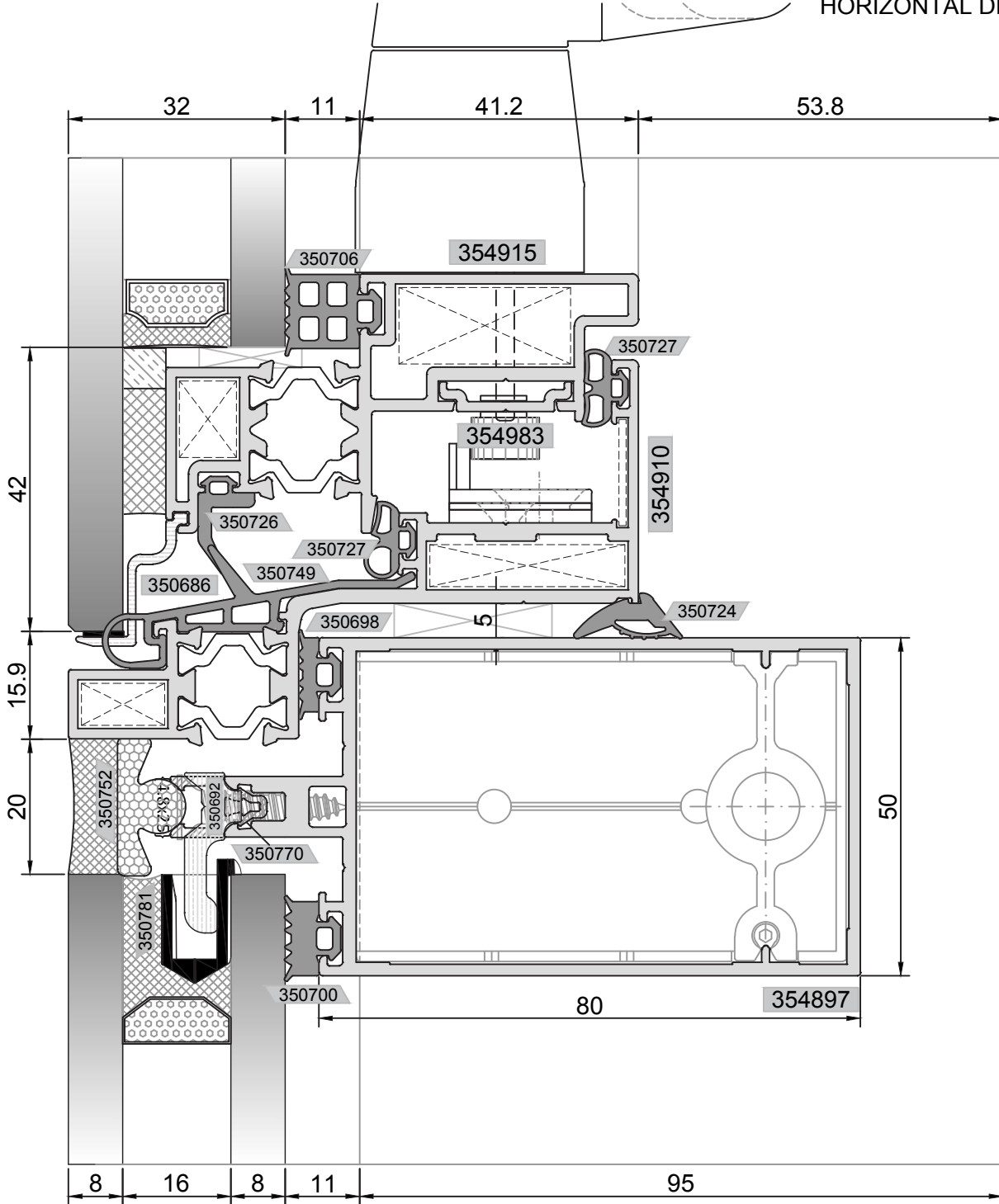

ALTERNATİF 2: YALITIMLI KANAT DETAYI  
ALTERNATIVE 2 : INSULATED VENT DETAIL

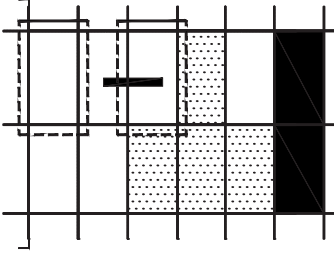

DÜŞEY DETAYI  
VERTICAL DETAIL

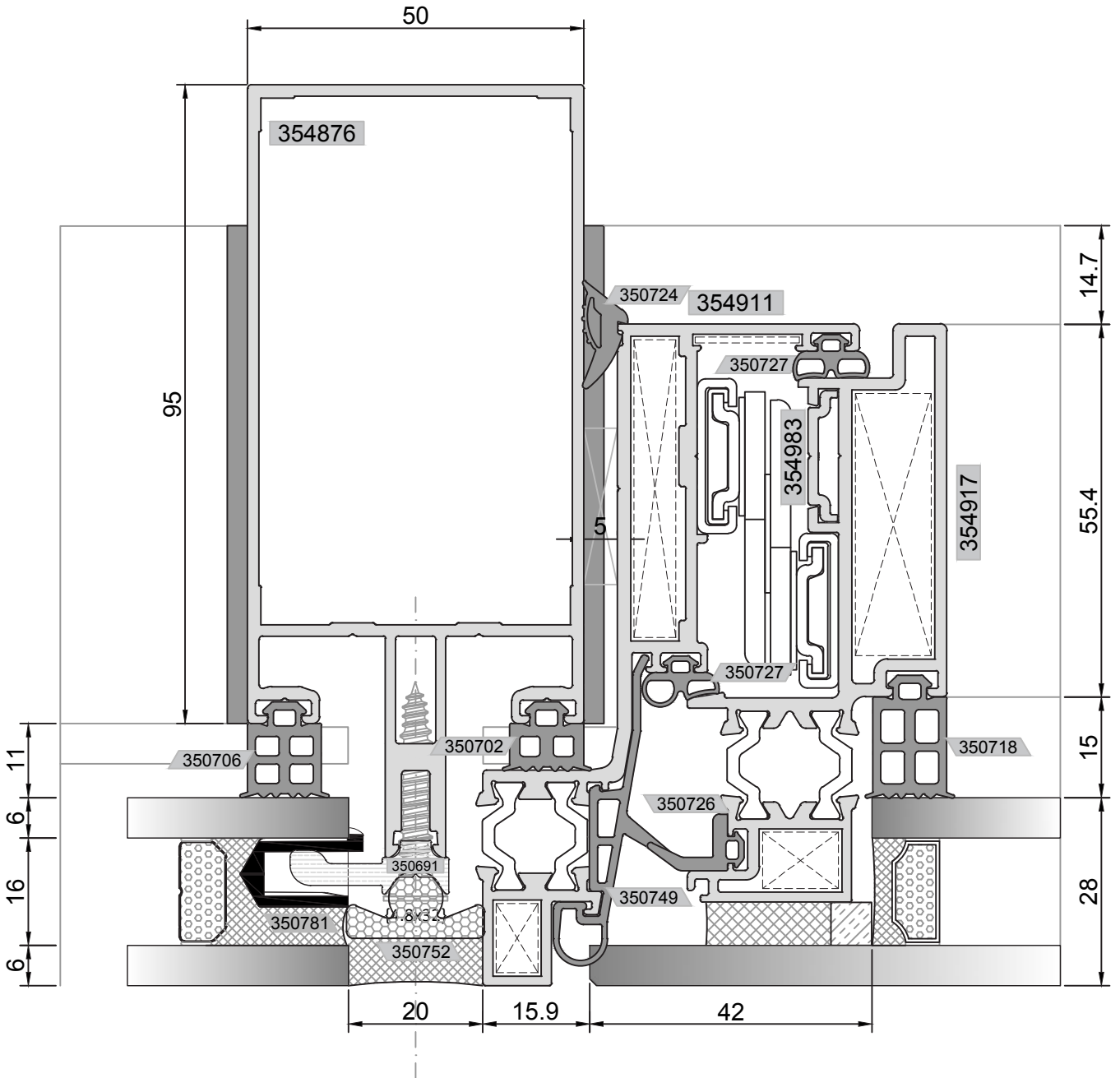

ALTERNATİF 1: YALITIMLI PARALEL AÇILIR KANAT DETAYI  
ALTERNATIVE 1 : PARALEL OPENING INSULATED VENT DETAIL

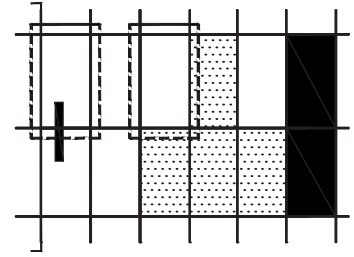

YATAY DETAYI  
HORIZONTAL DETAIL

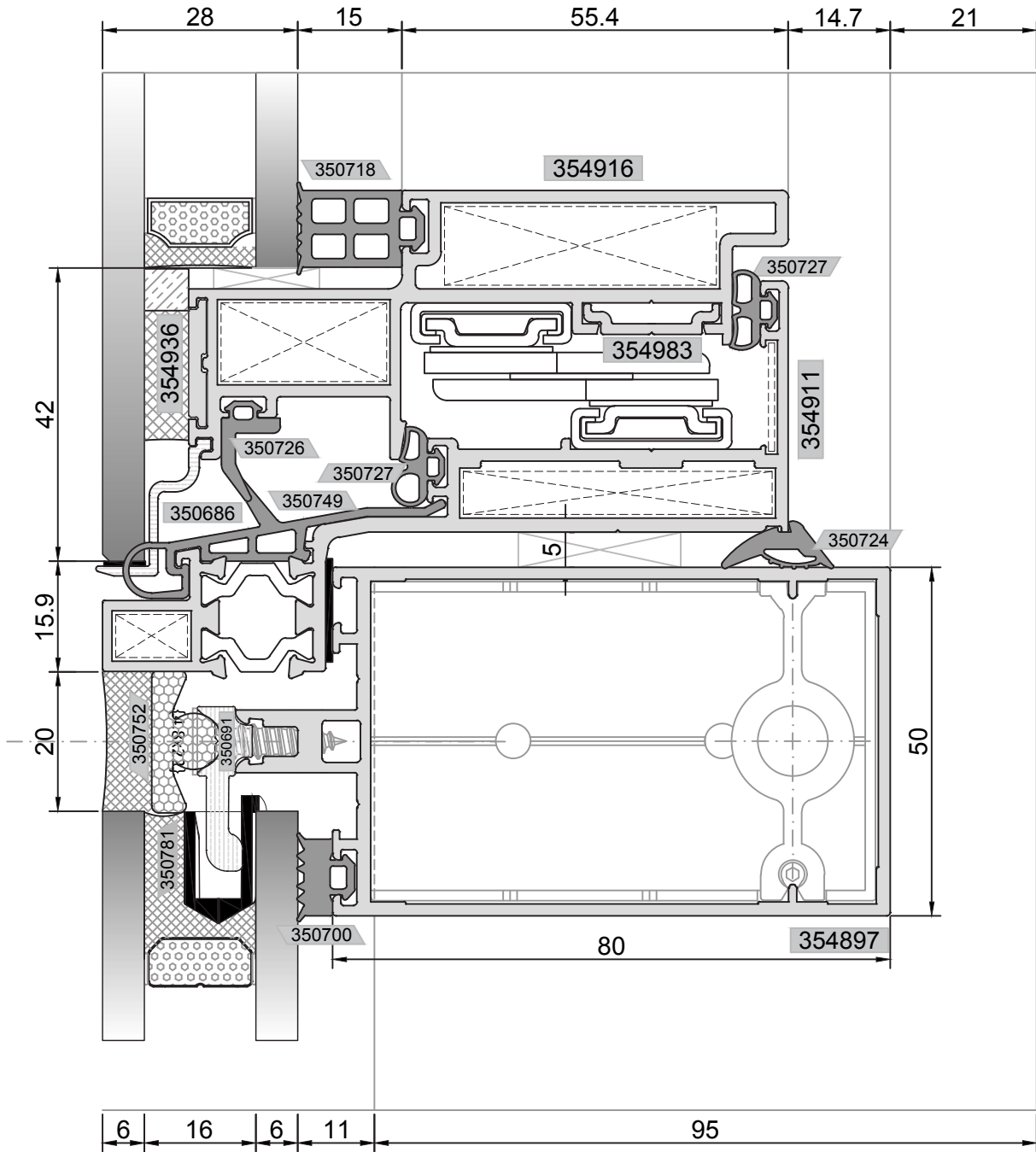

ALTERNATİF 2: YALITIMSIZ PARALEL AÇILIR KANAT DETAYI  
ALTERNATIVE 2 : PARALEL OPENING UNINSULATED VENT DETAIL

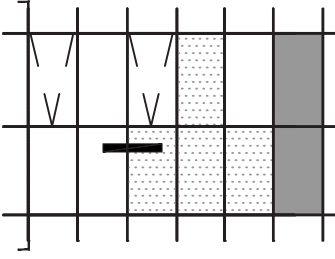

DÜŞEY DETAYI  
VERTICAL DETAIL

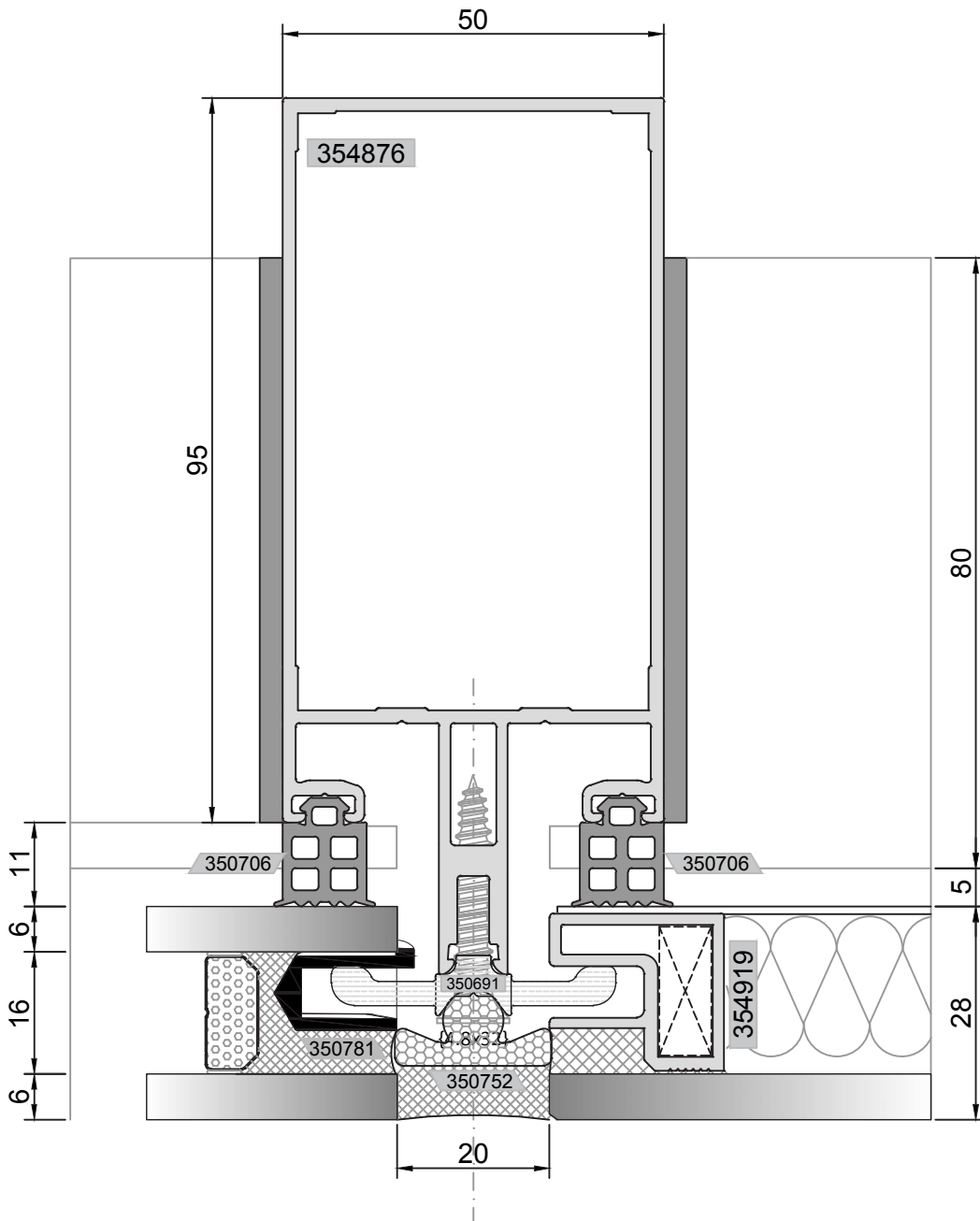

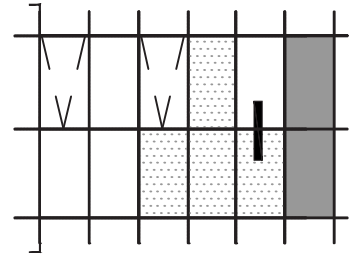

YATAY DETAYI  
HORIZONTAL DETAIL

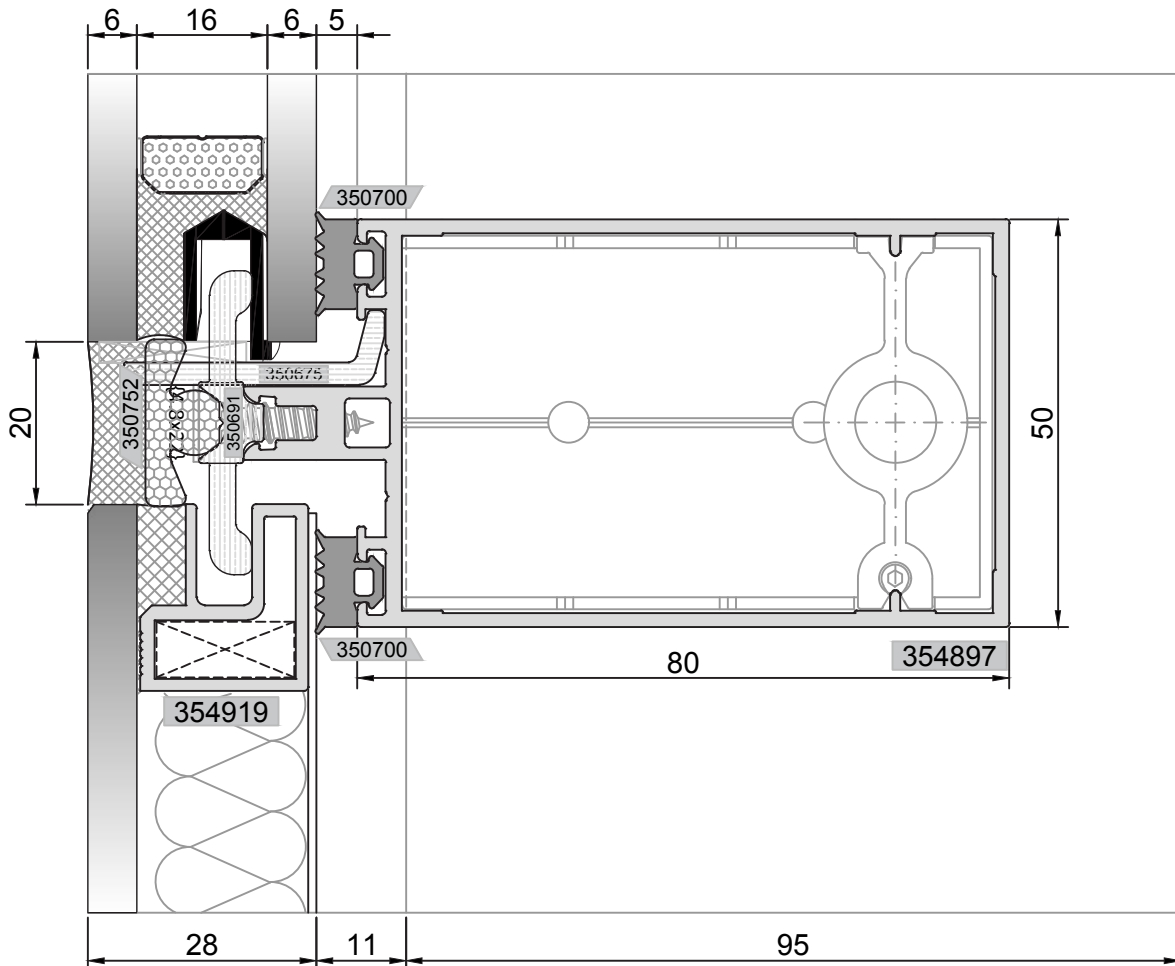



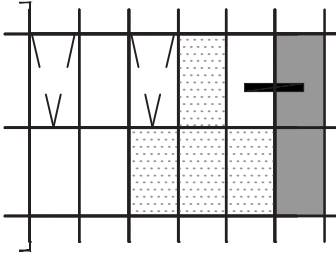

DÜŞEY DETAYI  
VERTICAL DETAIL

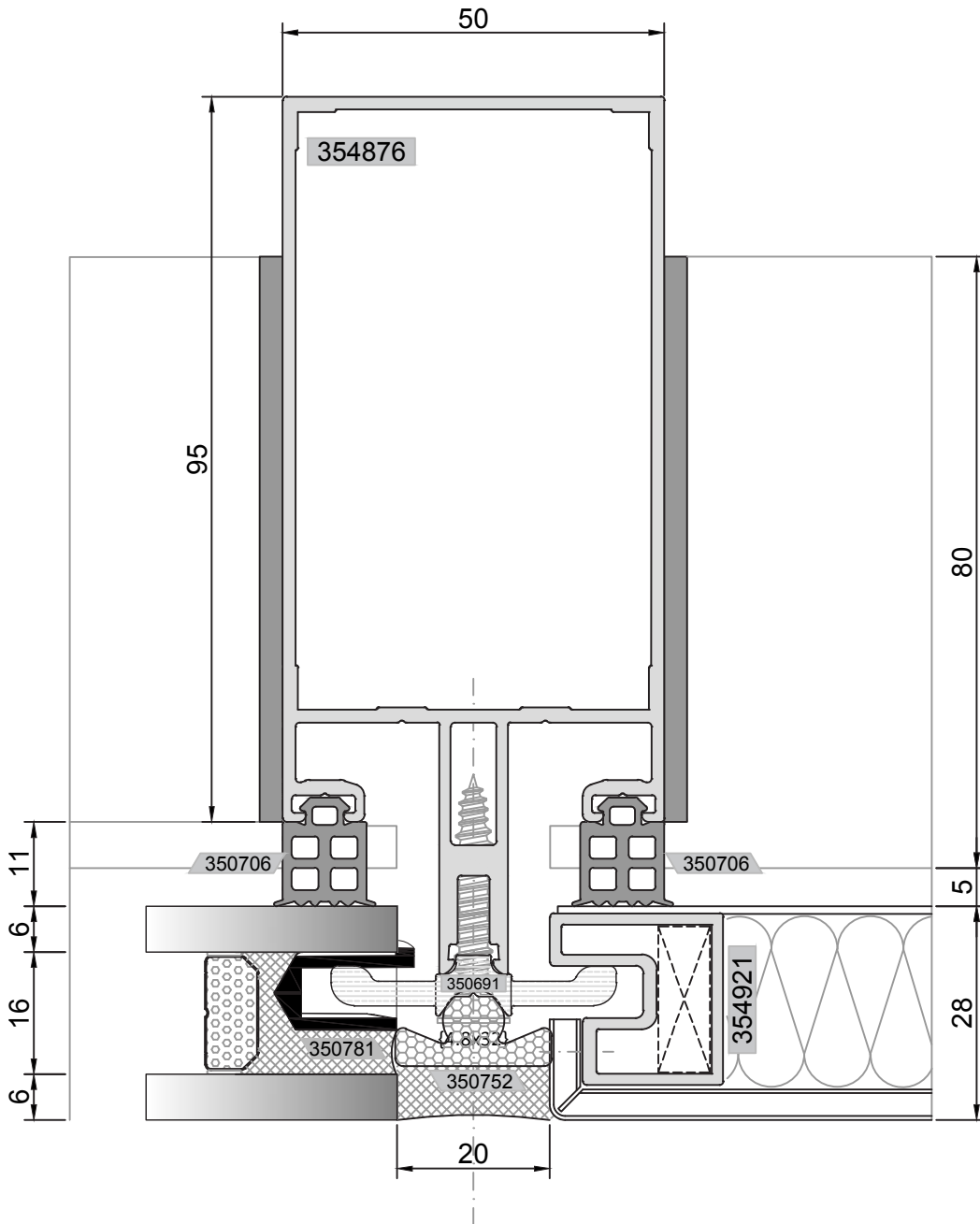

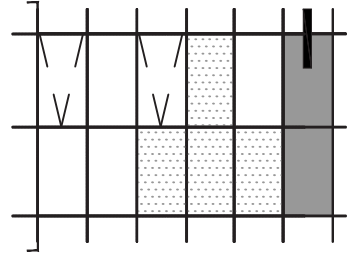

YATAY DETAYI  
HORIZONTAL DETAIL

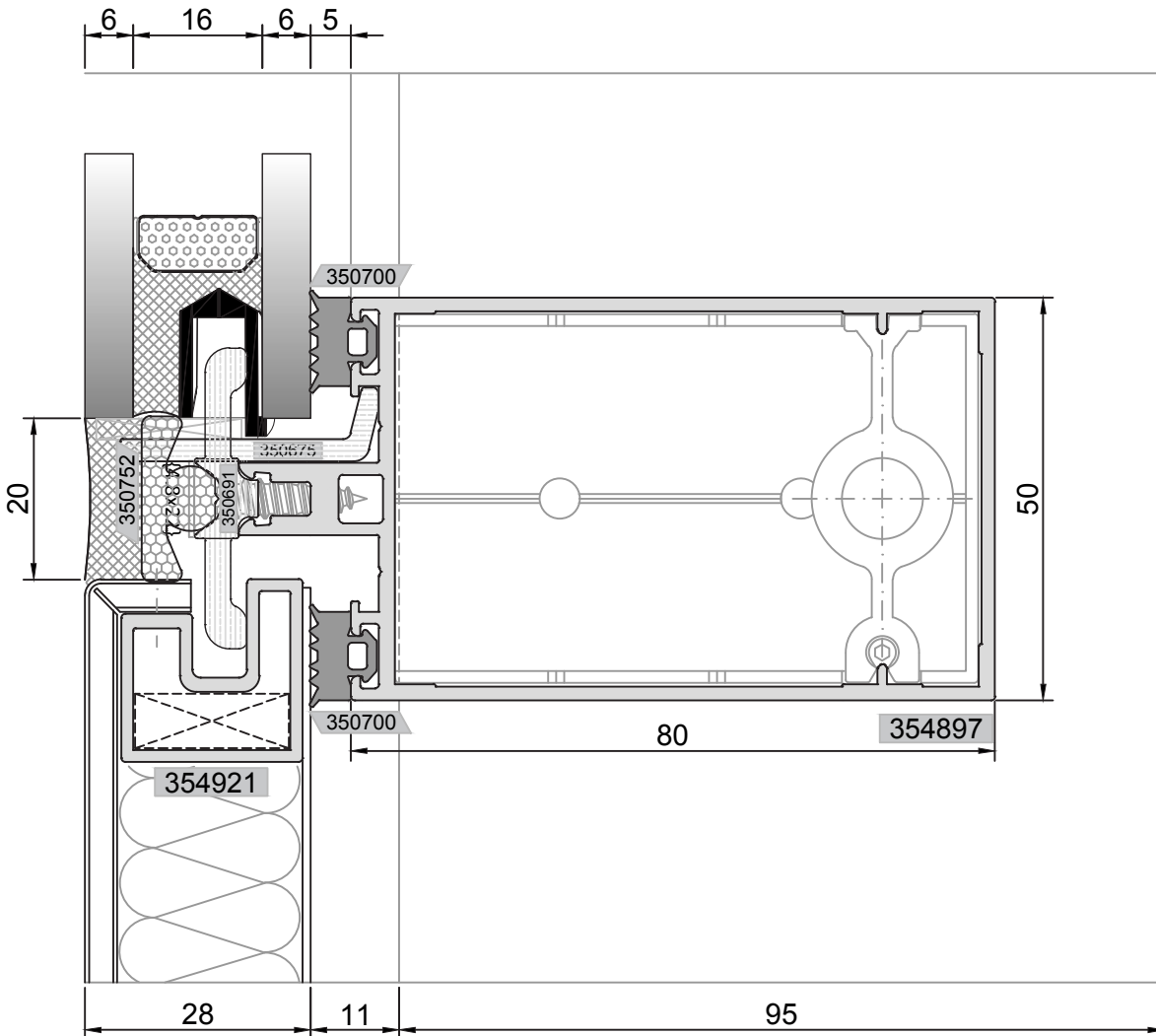

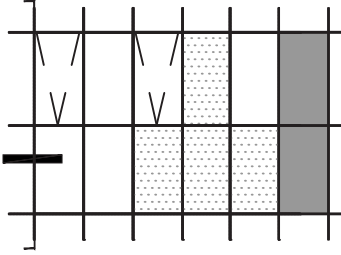

DÜŞEY DETAYI  
VERTICAL DETAIL

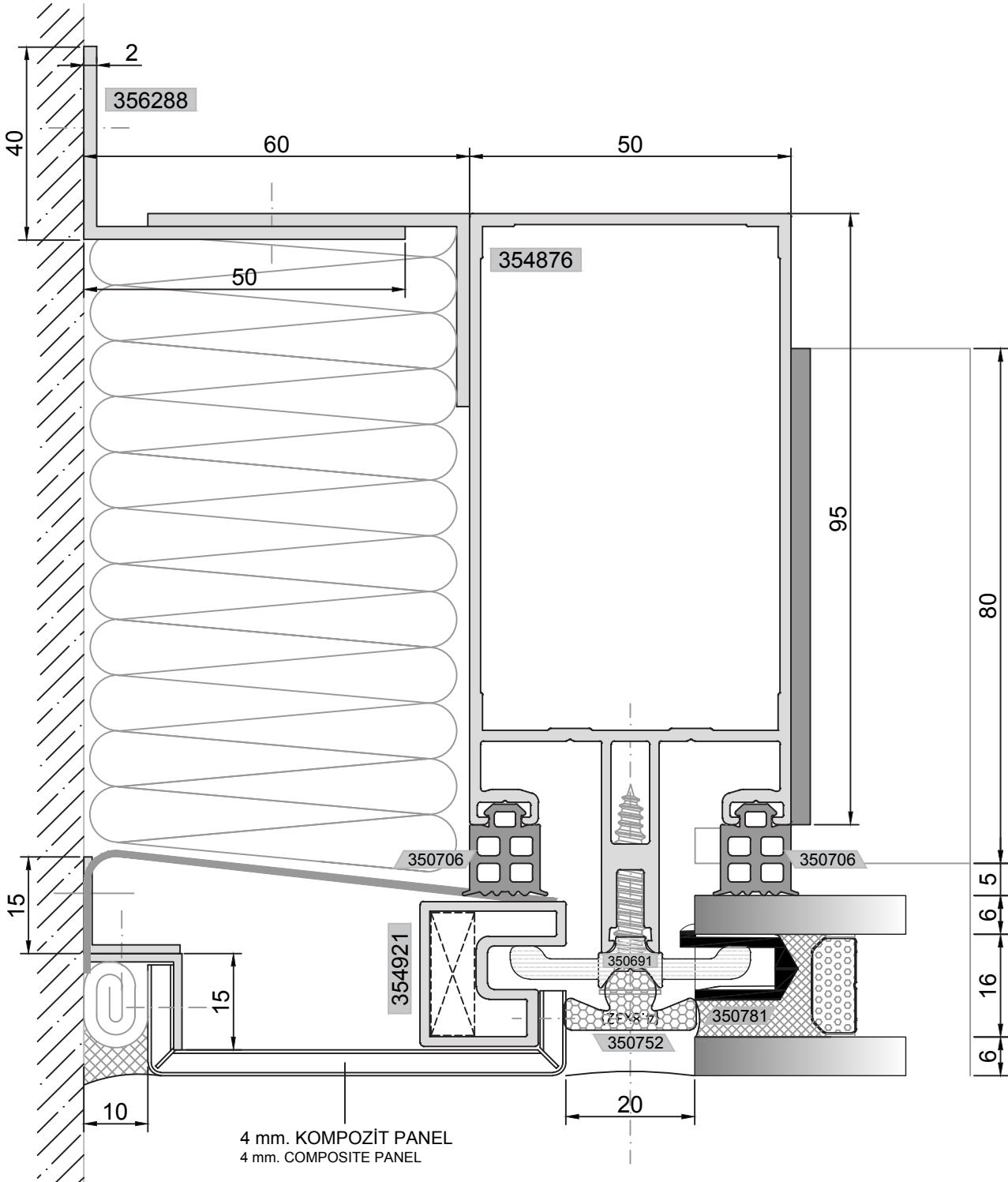

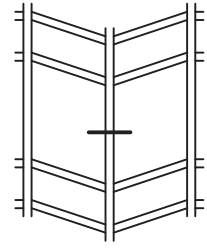

0° - 10°

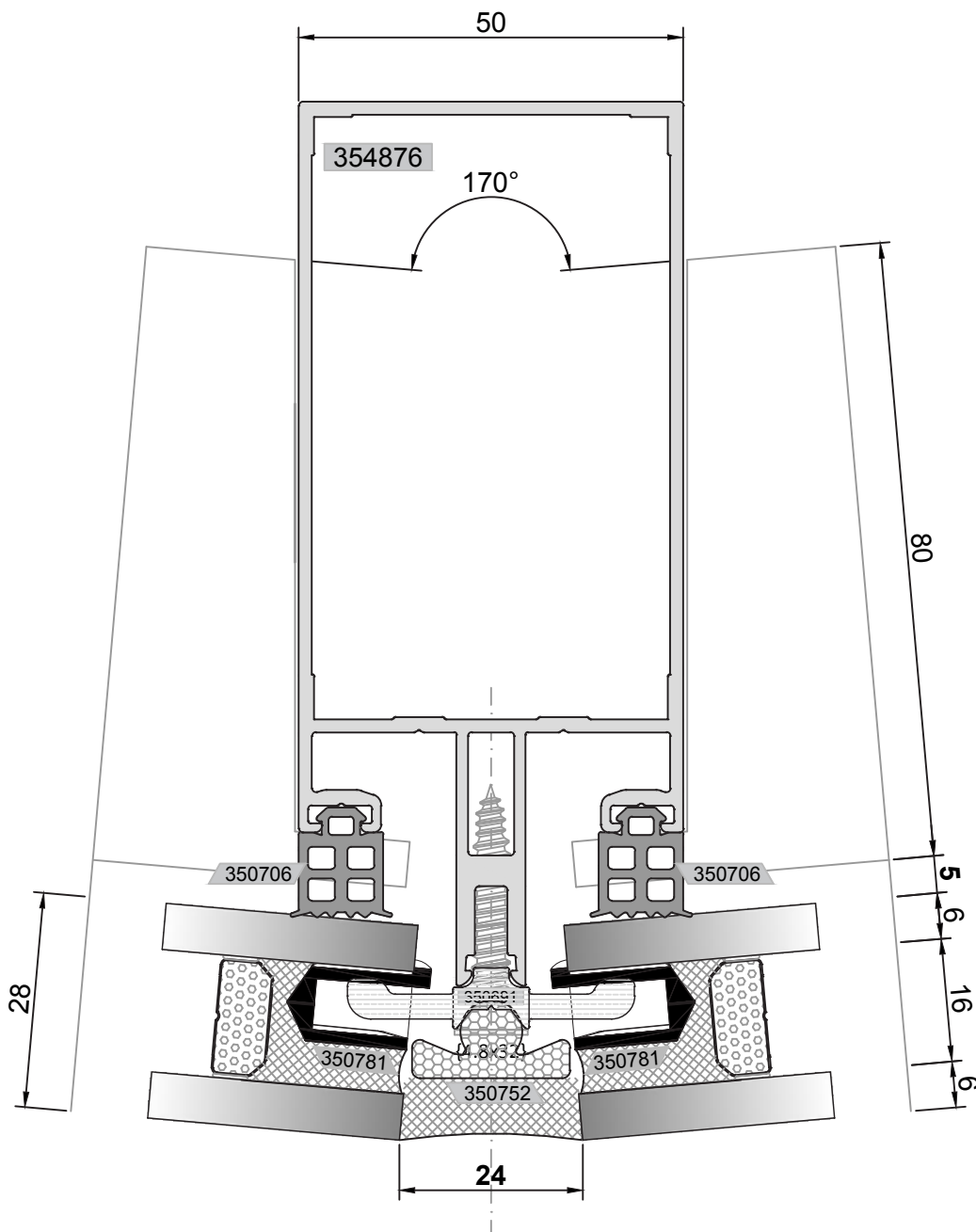

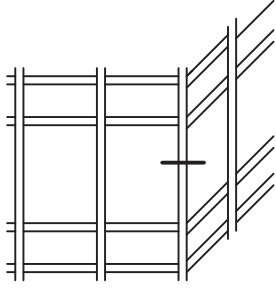

90°

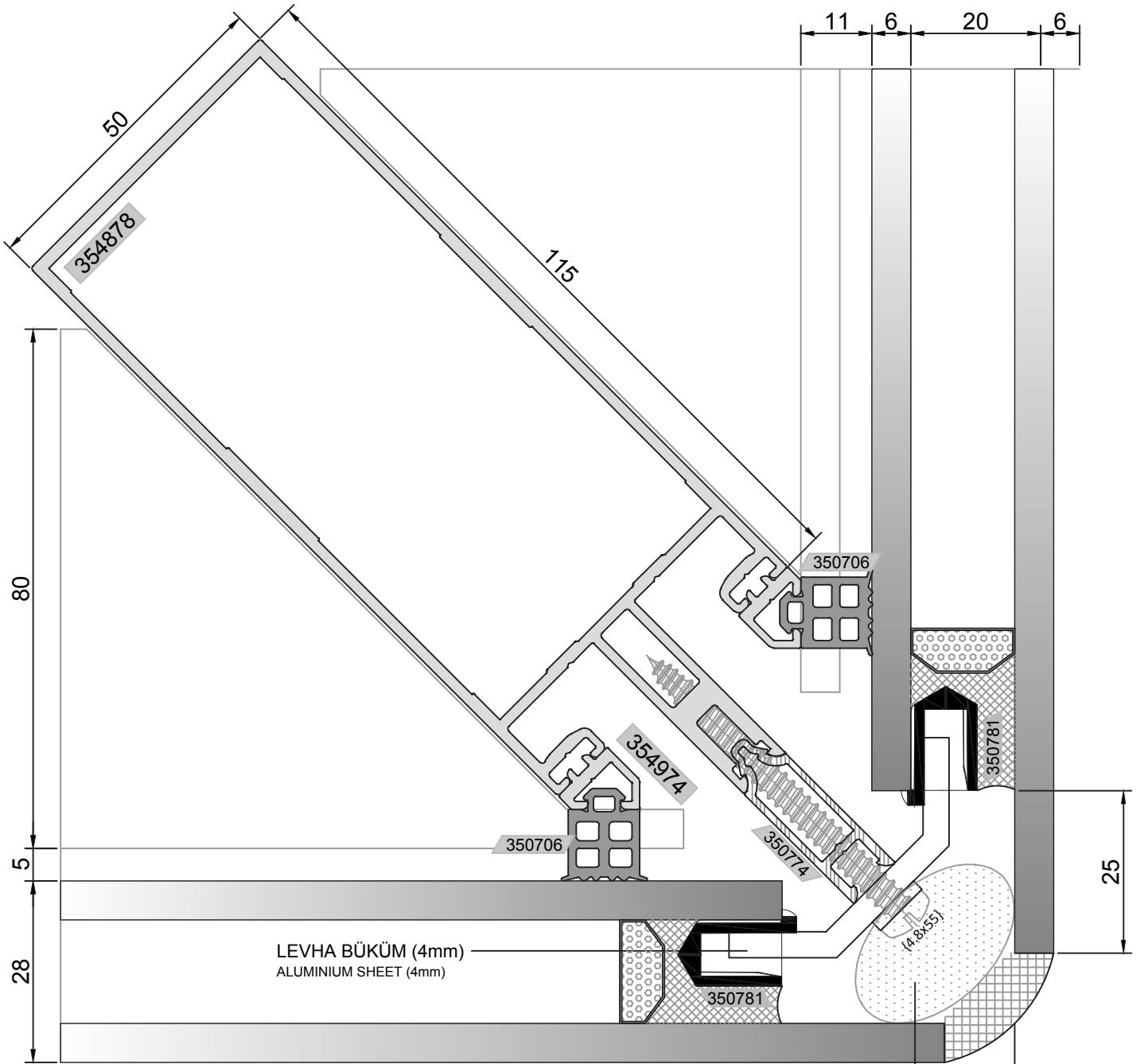

ALTERNATİF 1: TEK DİKMELİ KÖŞE DETAYI  
ALTERNATIVE 1 : CORNER DETAIL WITH SINGLE MULLION

SİLİKON  
SILICONE  
POLİETİLEN CONTA  
POLYETHYLENE GASKET

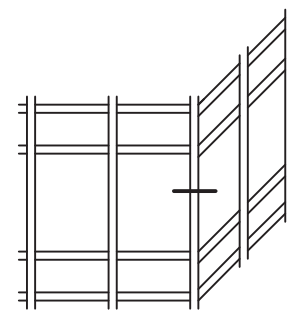

90°

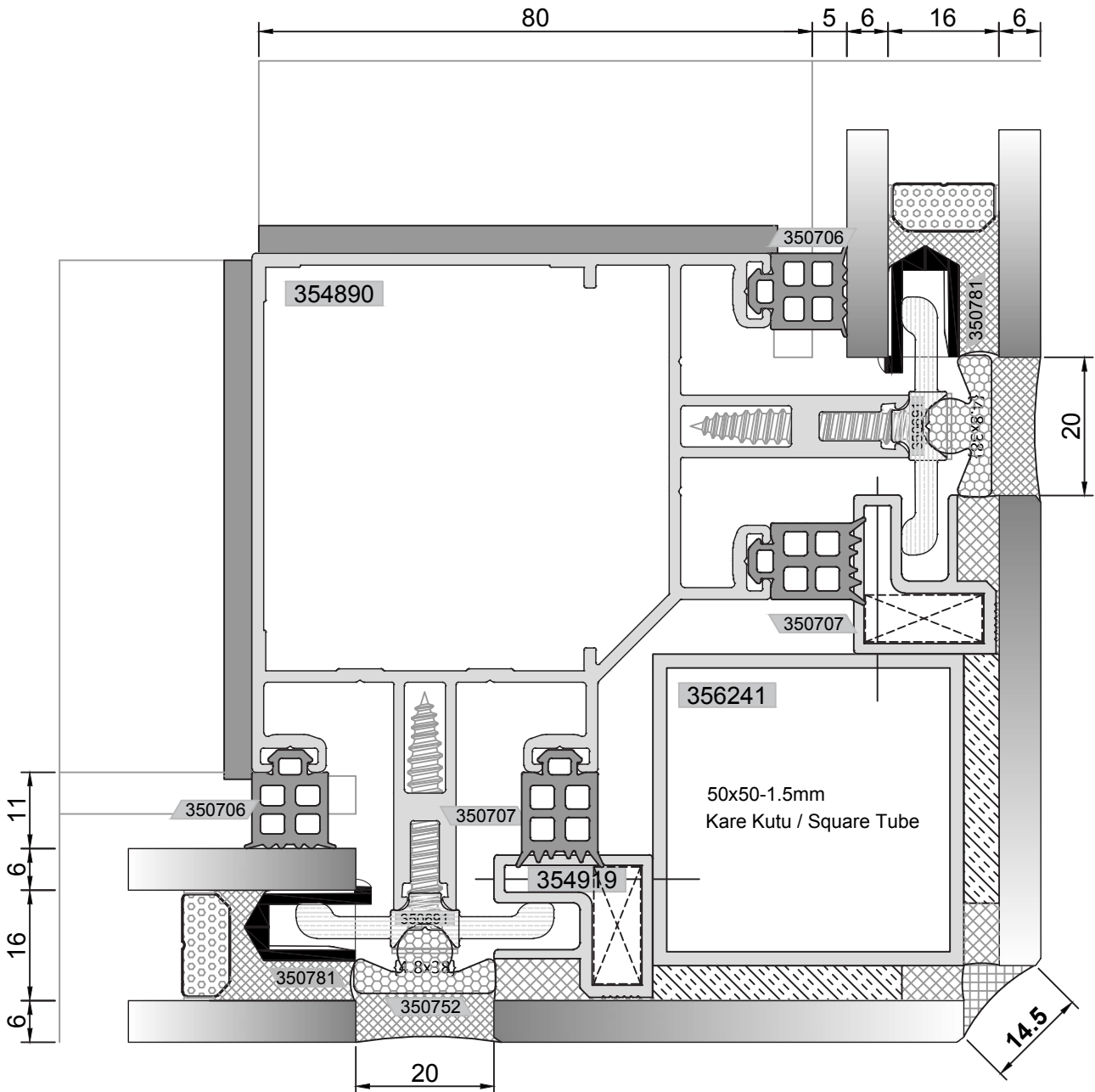

ALTERNATİF 2: ÇİFT DİKMELİ KÖŞE DETAYI  
ALTERNATIVE 2 : CORNER DETAIL WITH DOUBLE MULLION

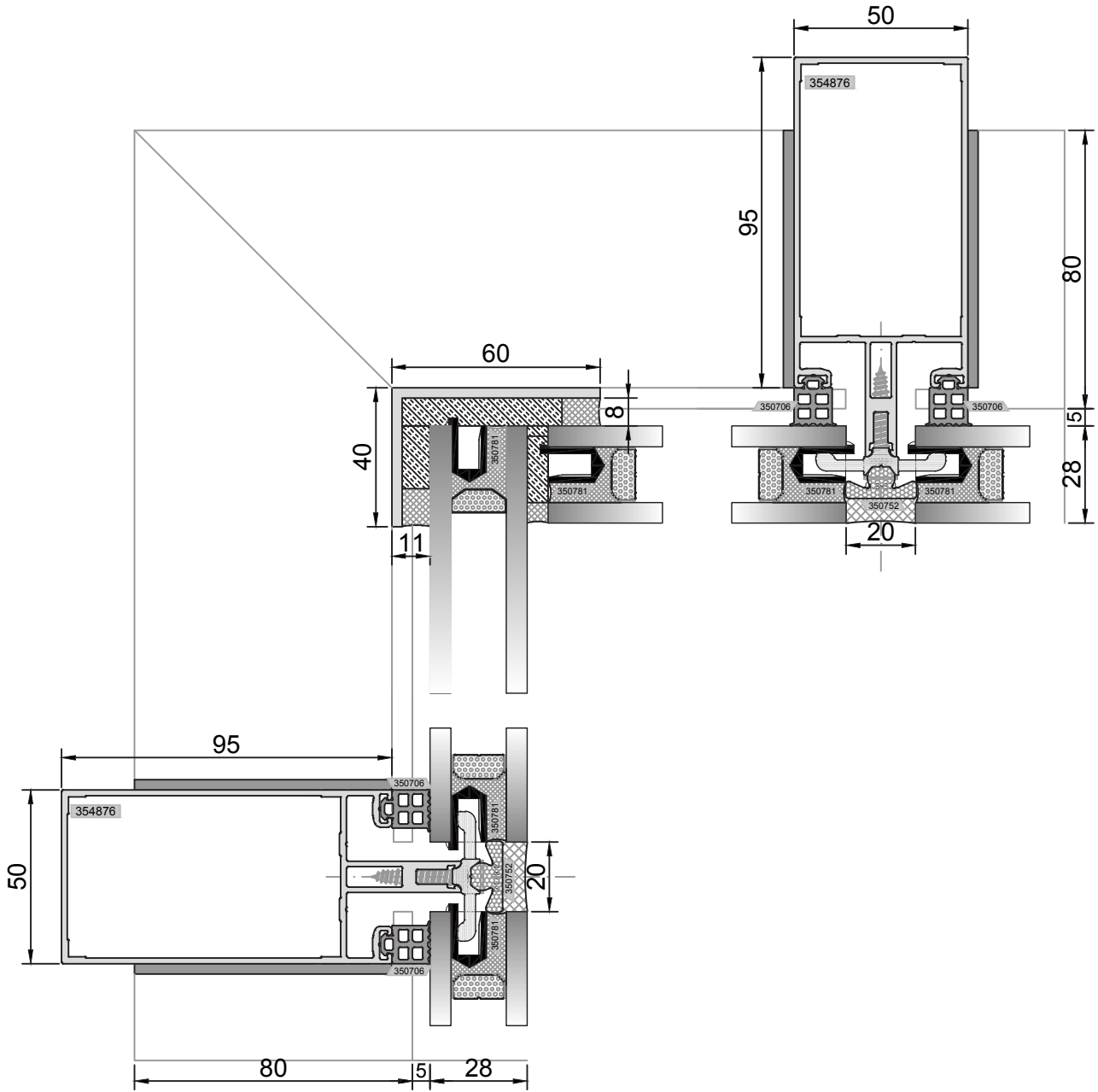
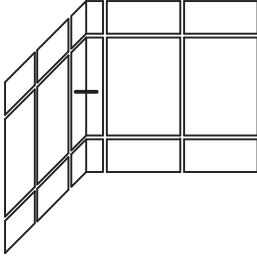

90° İÇ AÇILI CAM CEPHE DÜŞEY KESİT DETAYI  
FOUR SIDE WITH 90° INTERNAL ANGLE VERTICAL DETAIL

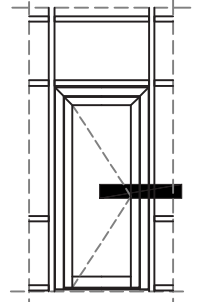
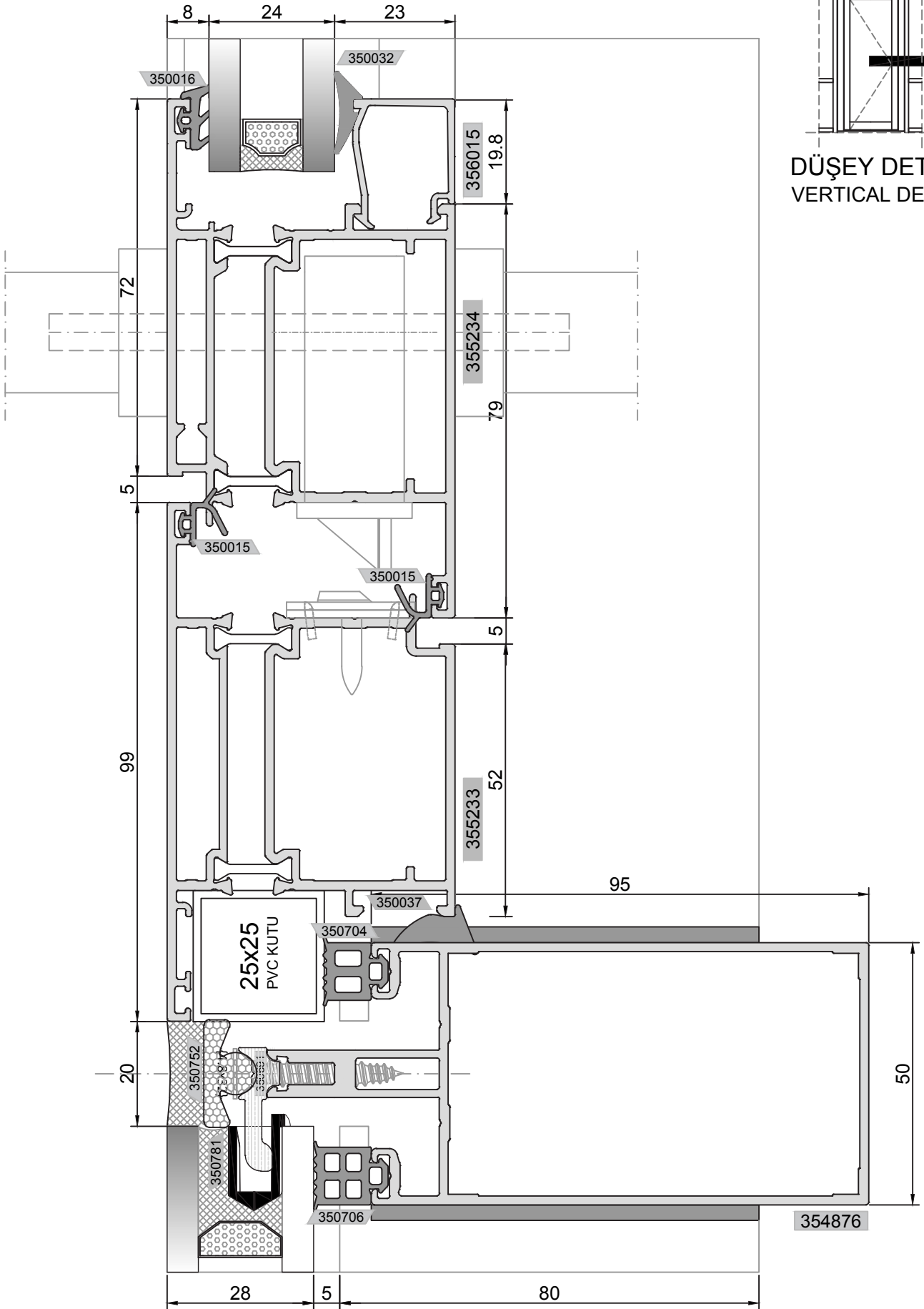

DÜŞEY DETAYI  
VERTICAL DETAIL



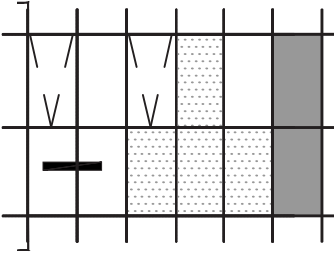

DÜŞEY DETAYI  
VERTICAL DETAIL

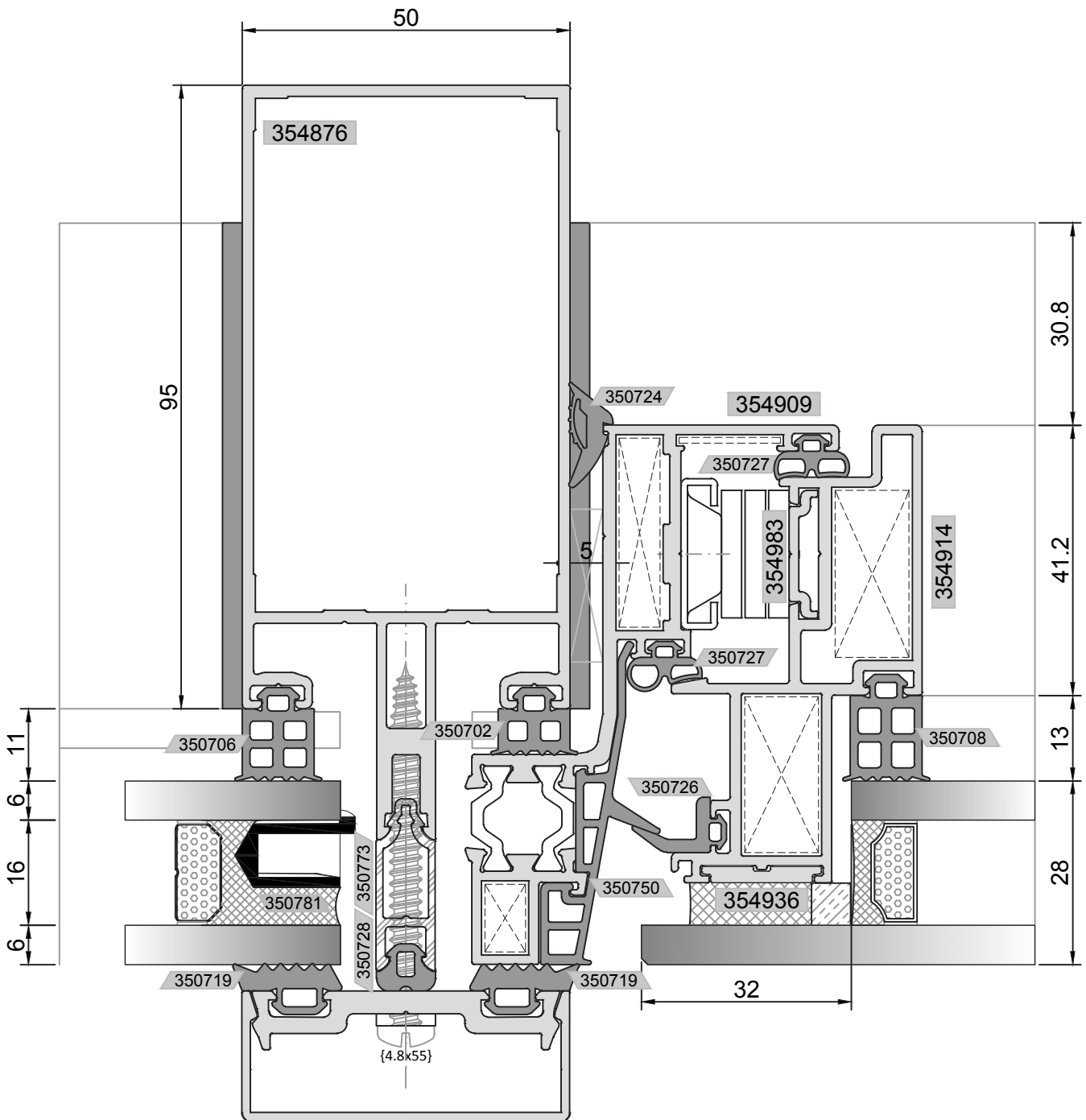

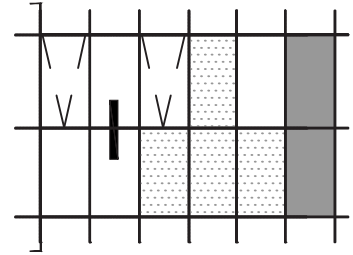

YATAY DETAYI  
HORIZONTAL DETAIL

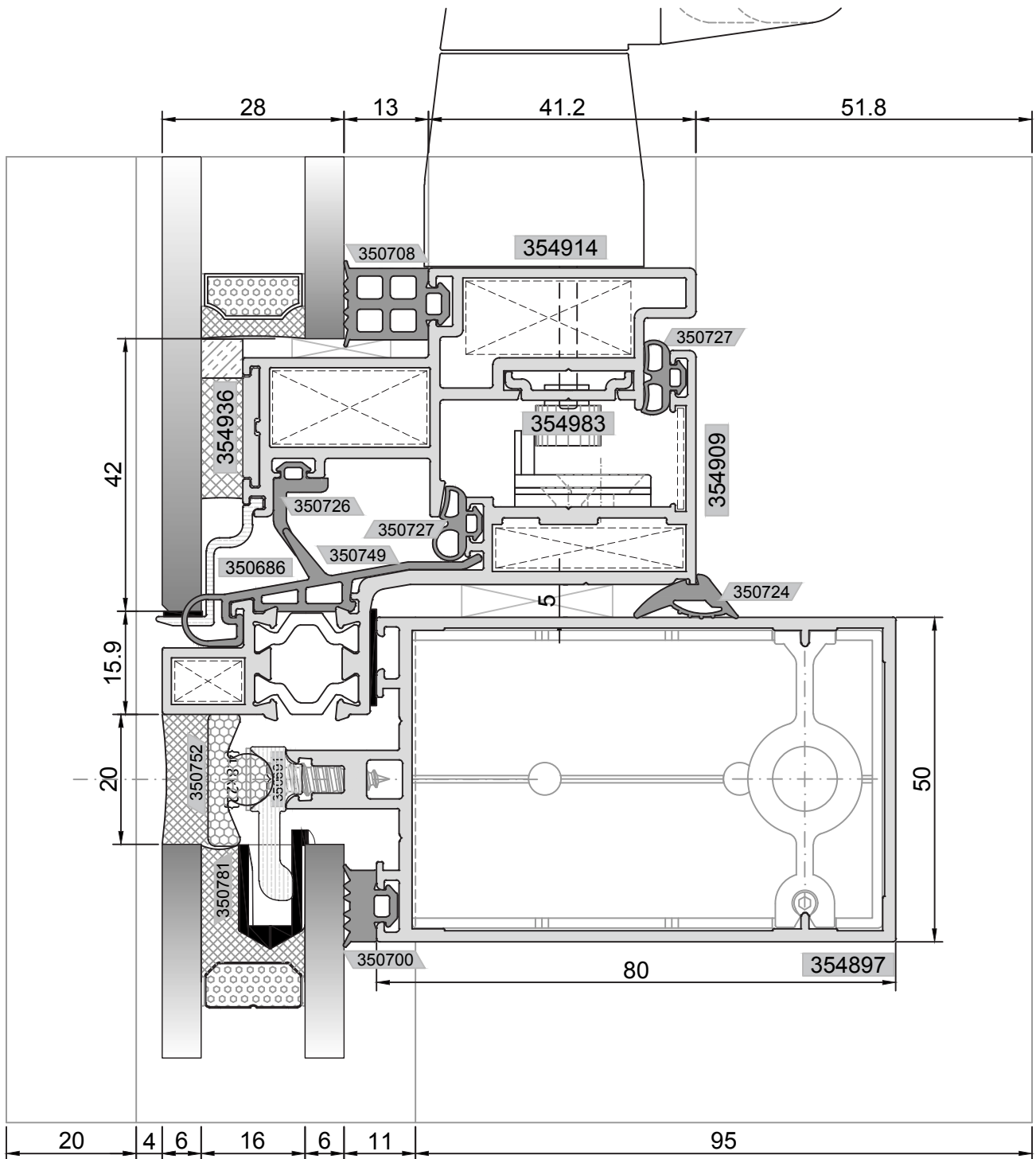

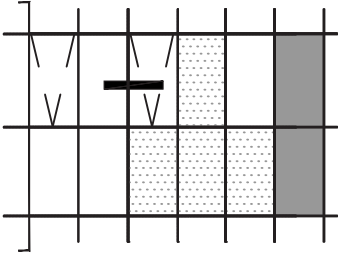

DÜŞEY DETAYI  
VERTICAL DETAIL

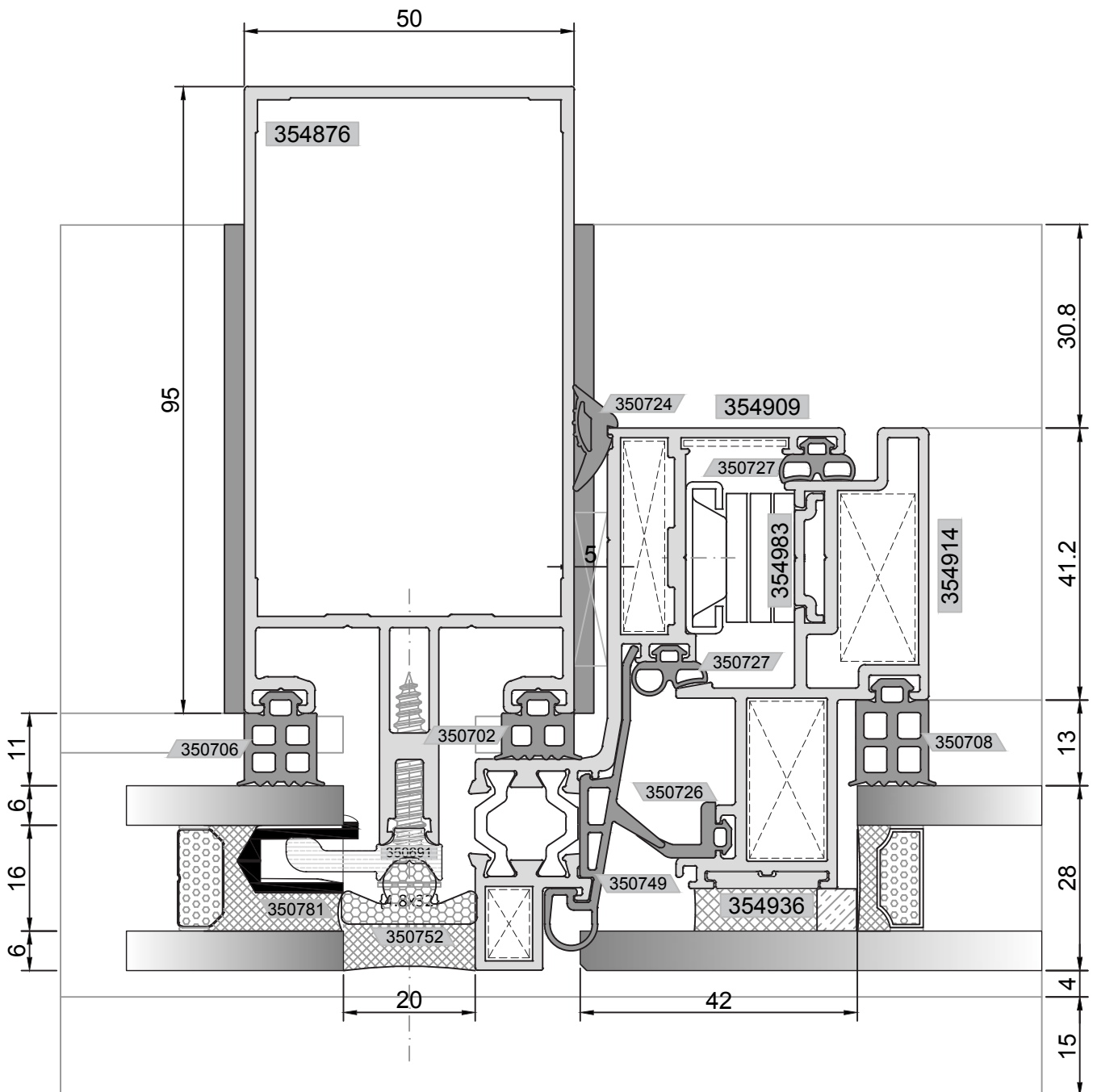

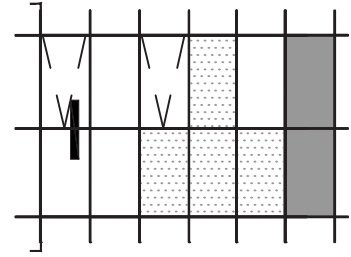

YATAY DETAYI  
HORIZONTAL DETAIL

