

YATAY DETAYI
HORIZONTAL DETAIL

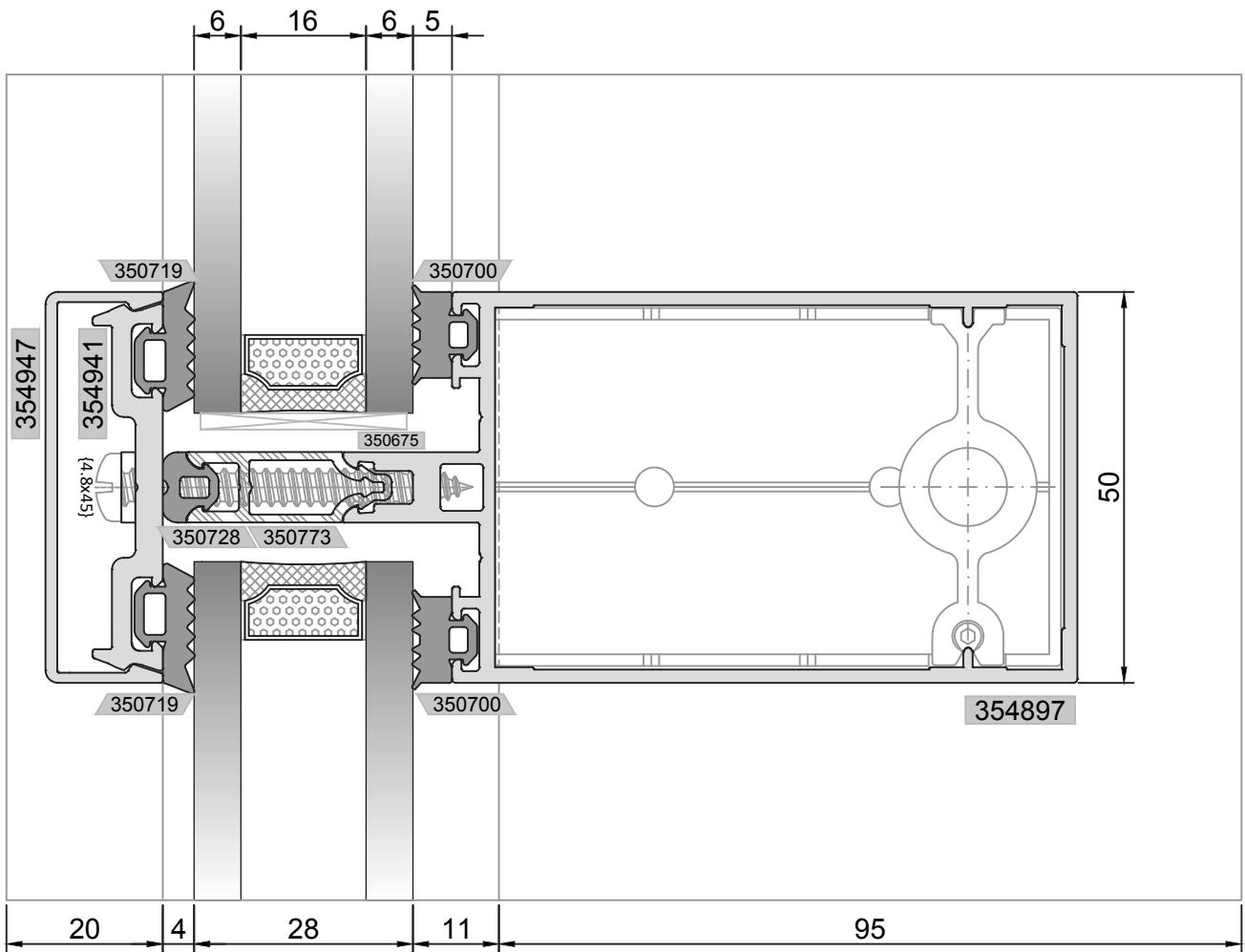

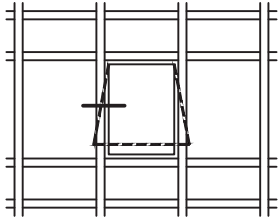

ALTERNATİF 1: YALITIMSIZ KANAT DETAYI
ALTERNATIVE 1 : UNINSULATED VENT DETAIL

DÜŞEY DETAYI
VERTICAL DETAIL

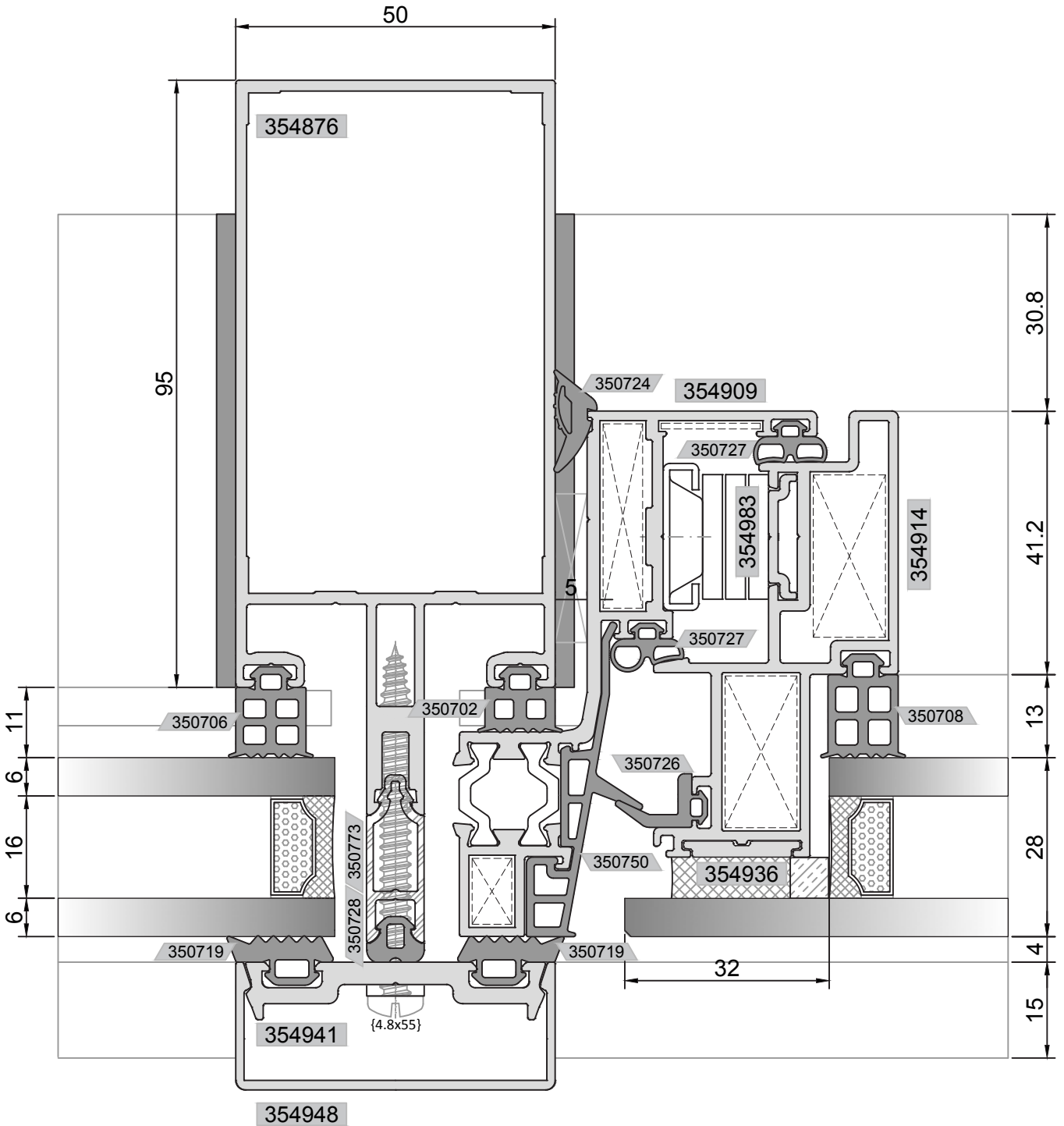

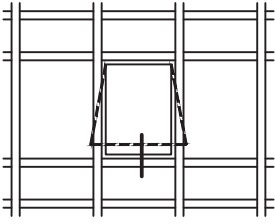

ALTERNATİF 1: YALITIMSIZ KANAT DETAYI
ALTERNATIVE 1 : UNINSULATED VENT DETAIL

YATAY DETAYI
HORIZONTAL DETAIL

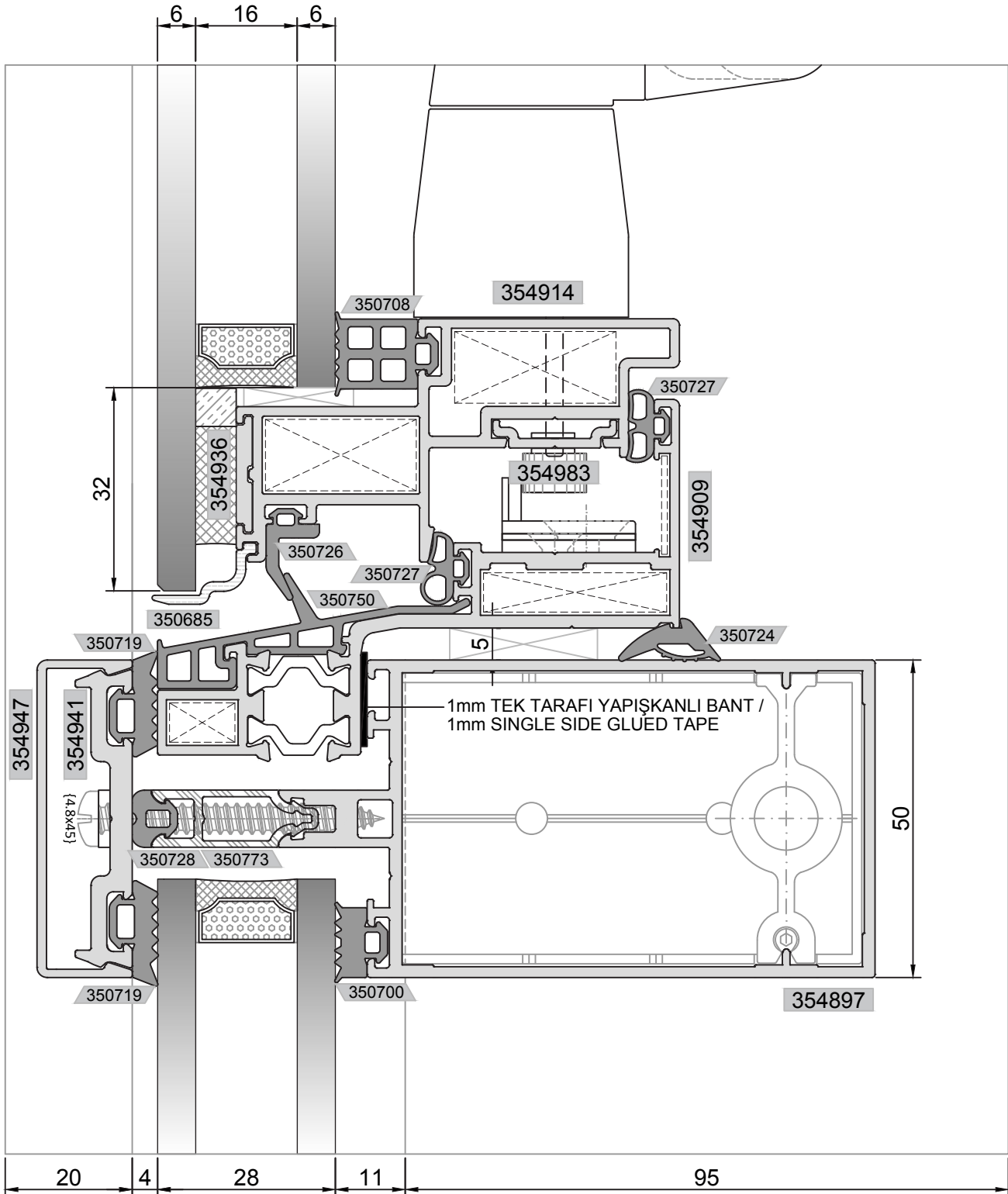

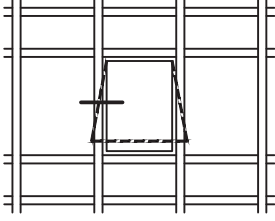

ALTERNATİF 2: YALITIMLI KANAT DETAYI
ALTERNATIVE 2 : INSULATED VENT DETAIL

DÜŞEY DETAYI
VERTICAL DETAIL

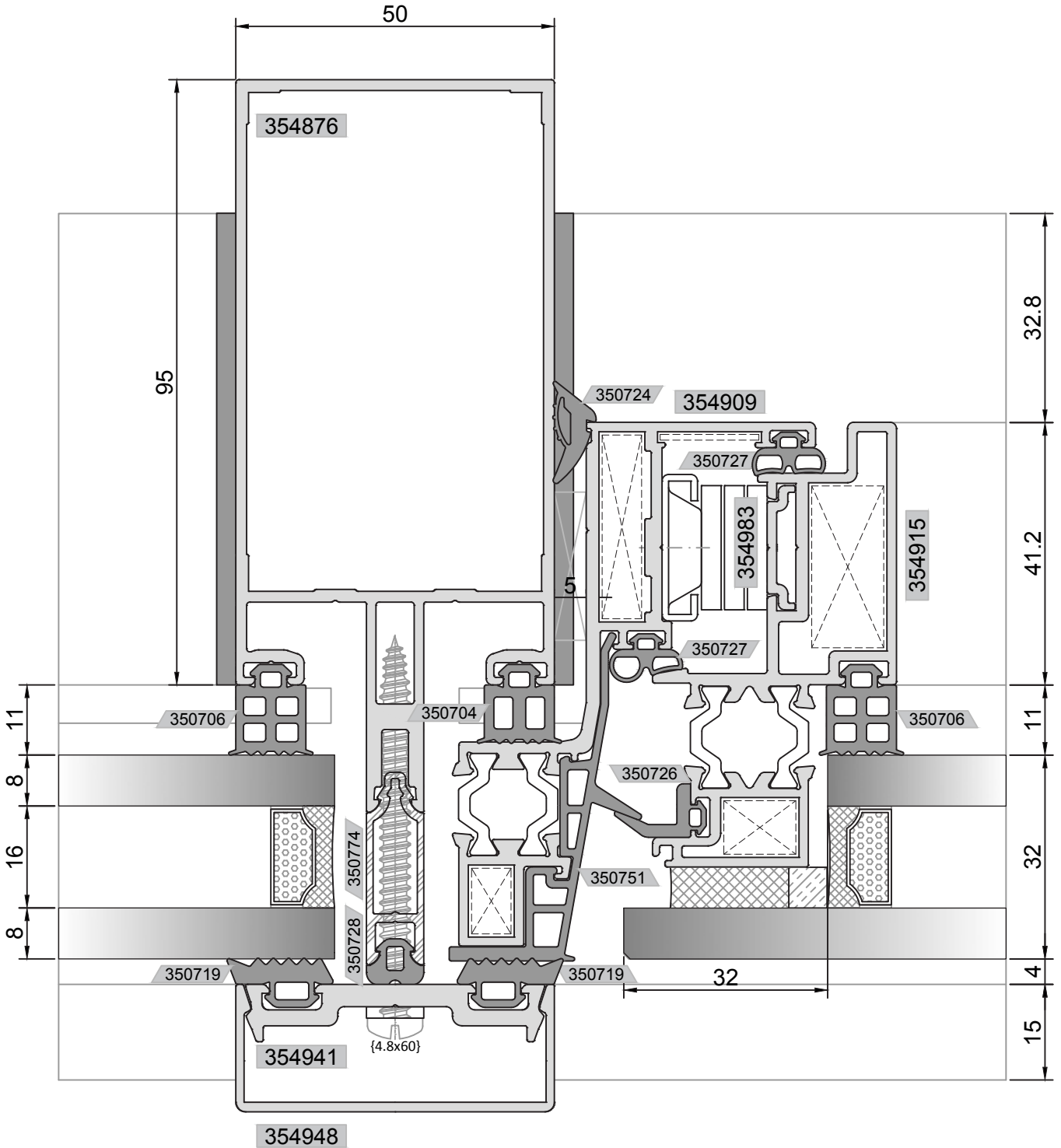

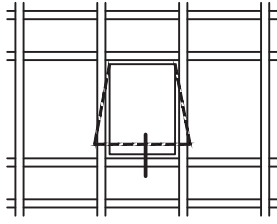

ALTERNATİF 2: YALITIMLI KANAT DETAYI
ALTERNATIVE 2 : INSULATED VENT DETAIL

YATAY DETAYI
HORIZONTAL DETAIL

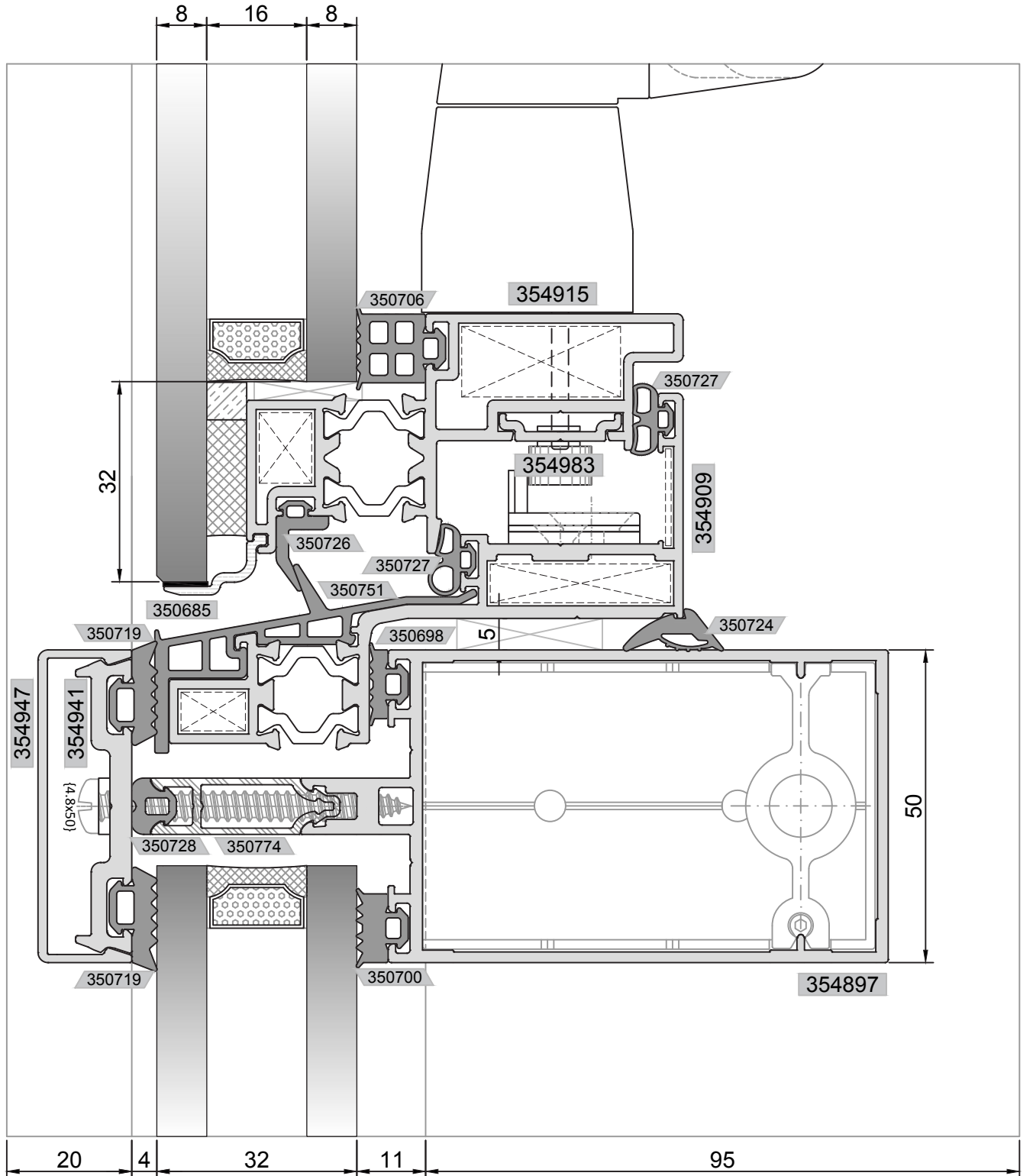

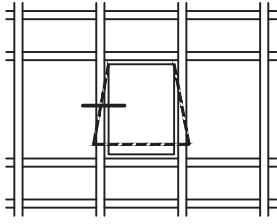

ALTERNATİF 3: EKONOMİK KANAT DETAYI
ALTERNATIVE 3 : ECONOMICAL VENT DETAIL

DÜŞEY DETAYI
VERTICAL DETAIL

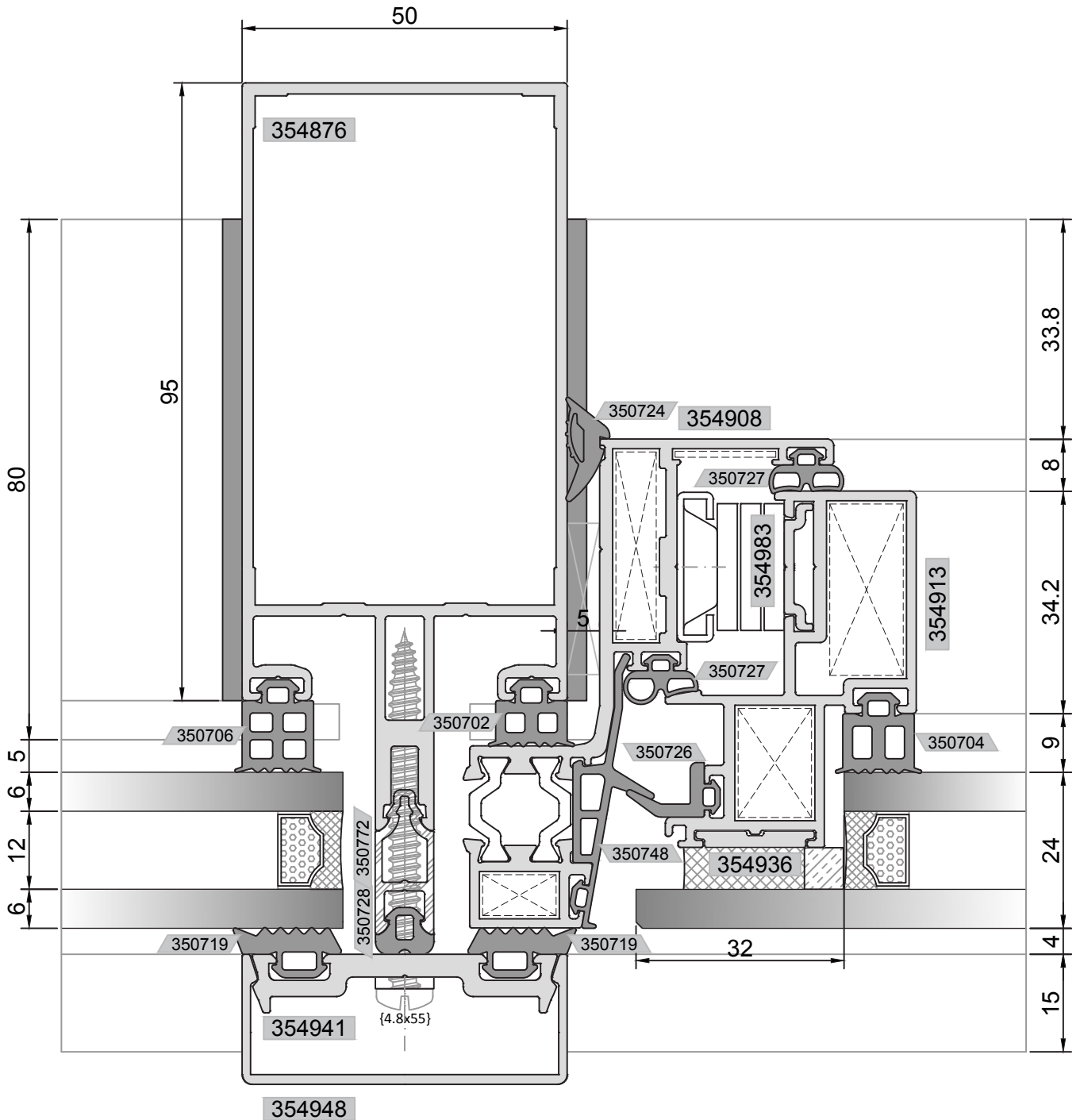

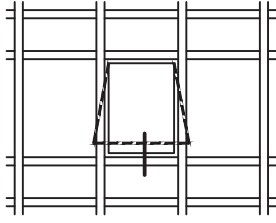

ALTERNATİF 3: EKONOMİK KANAT DETAYI
ALTERNATIVE 3 : ECONOMICAL VENT DETAIL

YATAY DETAYI
HORIZONTAL DETAIL

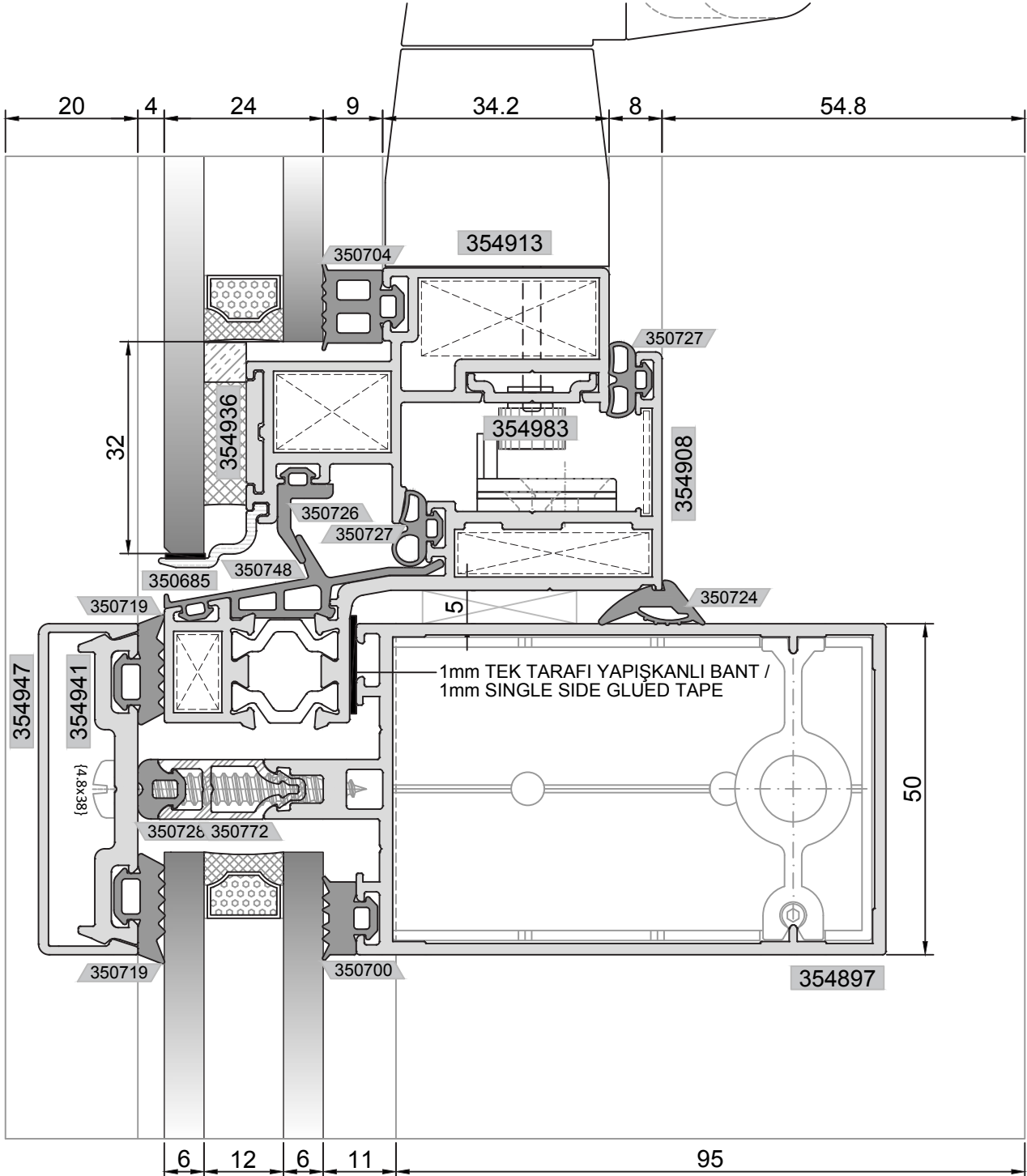

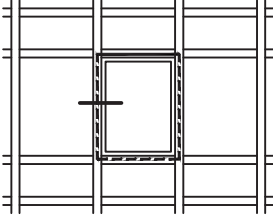

ALTERNATİF 1: YALITIMLI PARALEL AÇILIR KANAT DETAYI
ALTERNATIVE 1 : PARALLEL OPENING INSULATED VENT DETAIL

DÜŞEY DETAYI
VERTICAL DETAIL

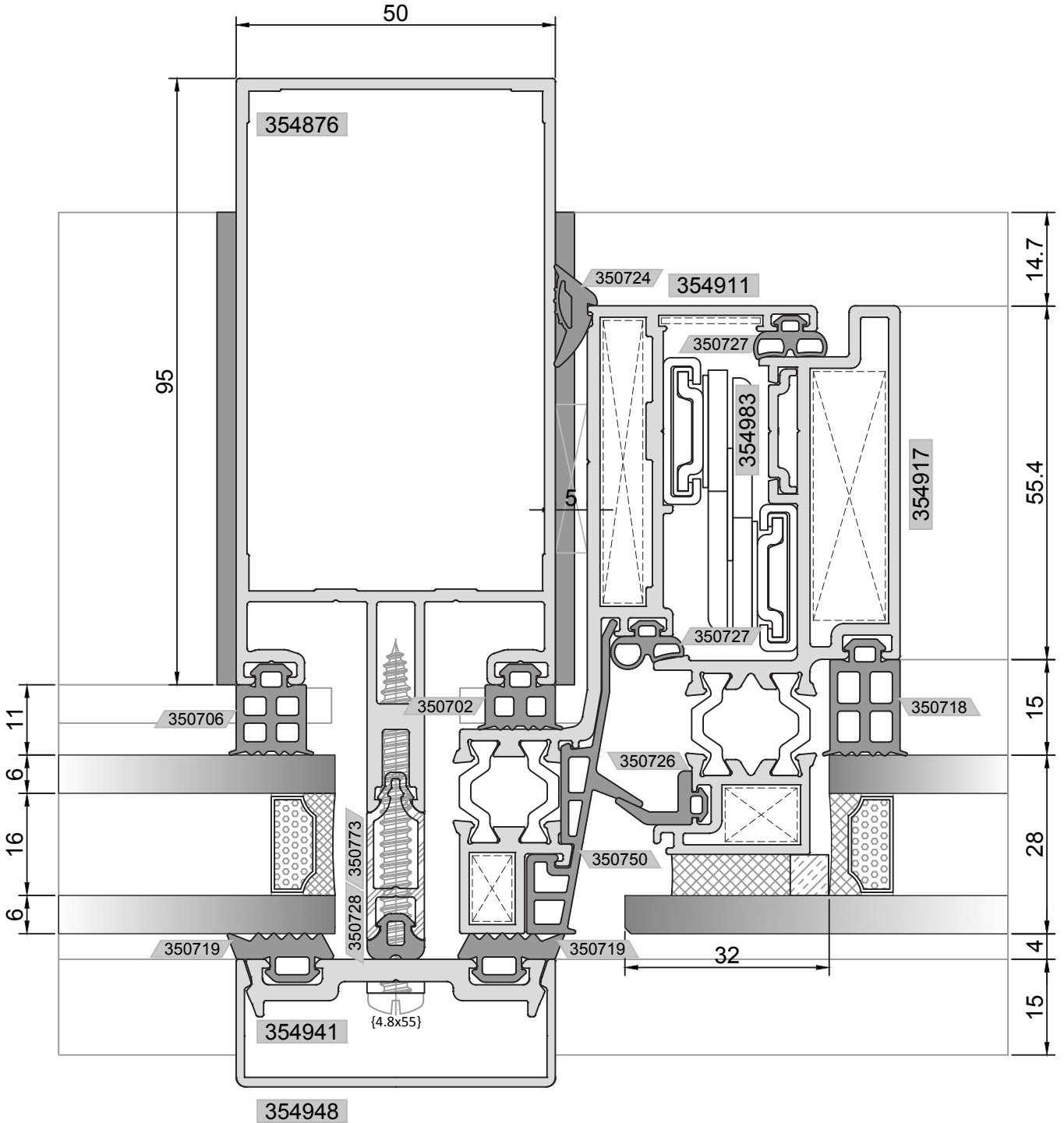

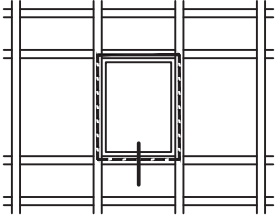

ALTERNATİF 2: YALITIMSIZ PARALEL AÇILIR KANAT DETAYI
ALTERNATIVE 2 : PARALLEL OPENING UNINSULATED VENT DETAIL

YATAY DETAYI
HORIZONTAL DETAIL

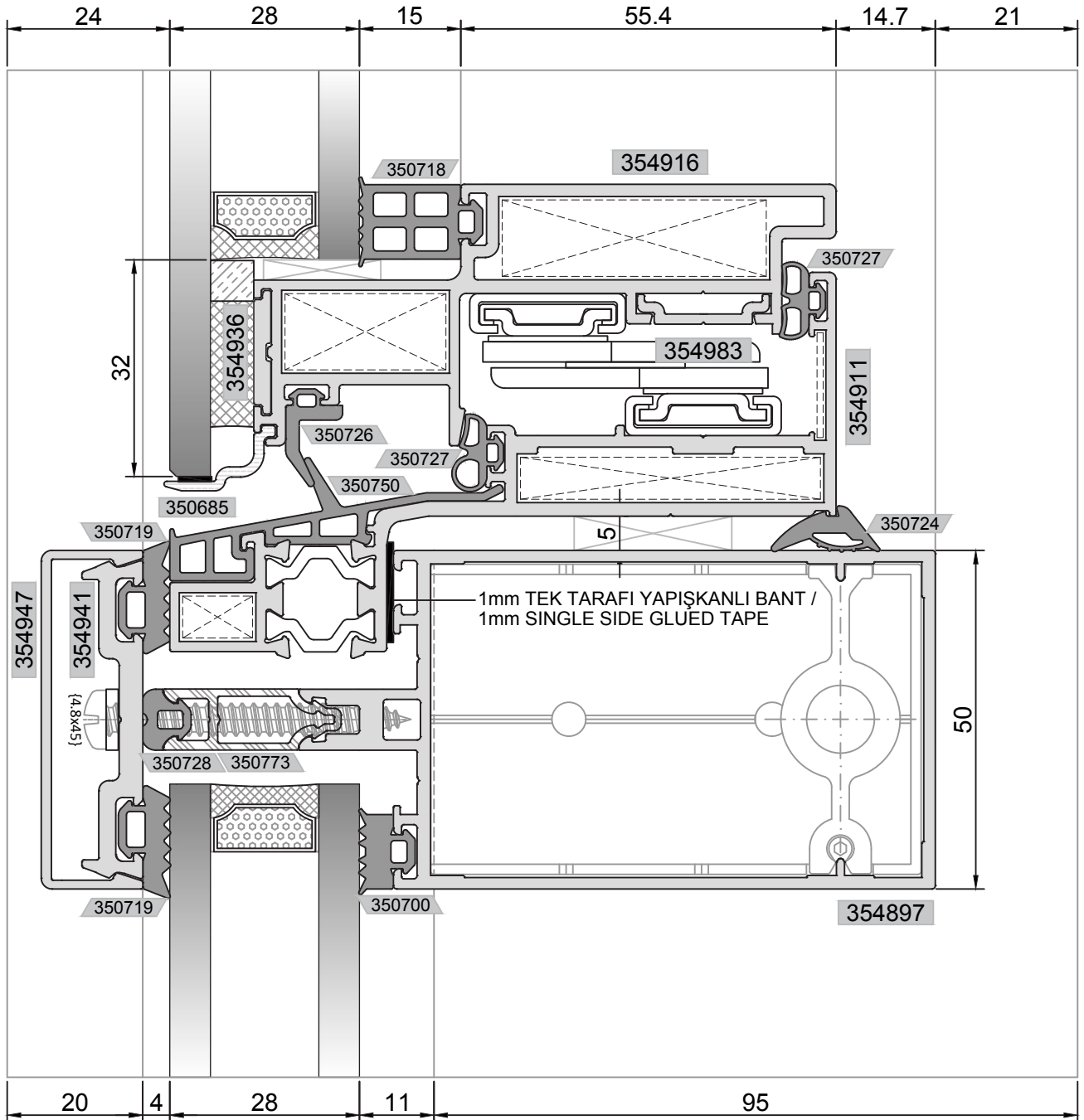

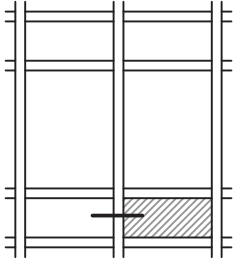

SPANDREL BÖLGE DÜŞEY DETAYI
SPANDREL AREA VERTICAL DETAIL

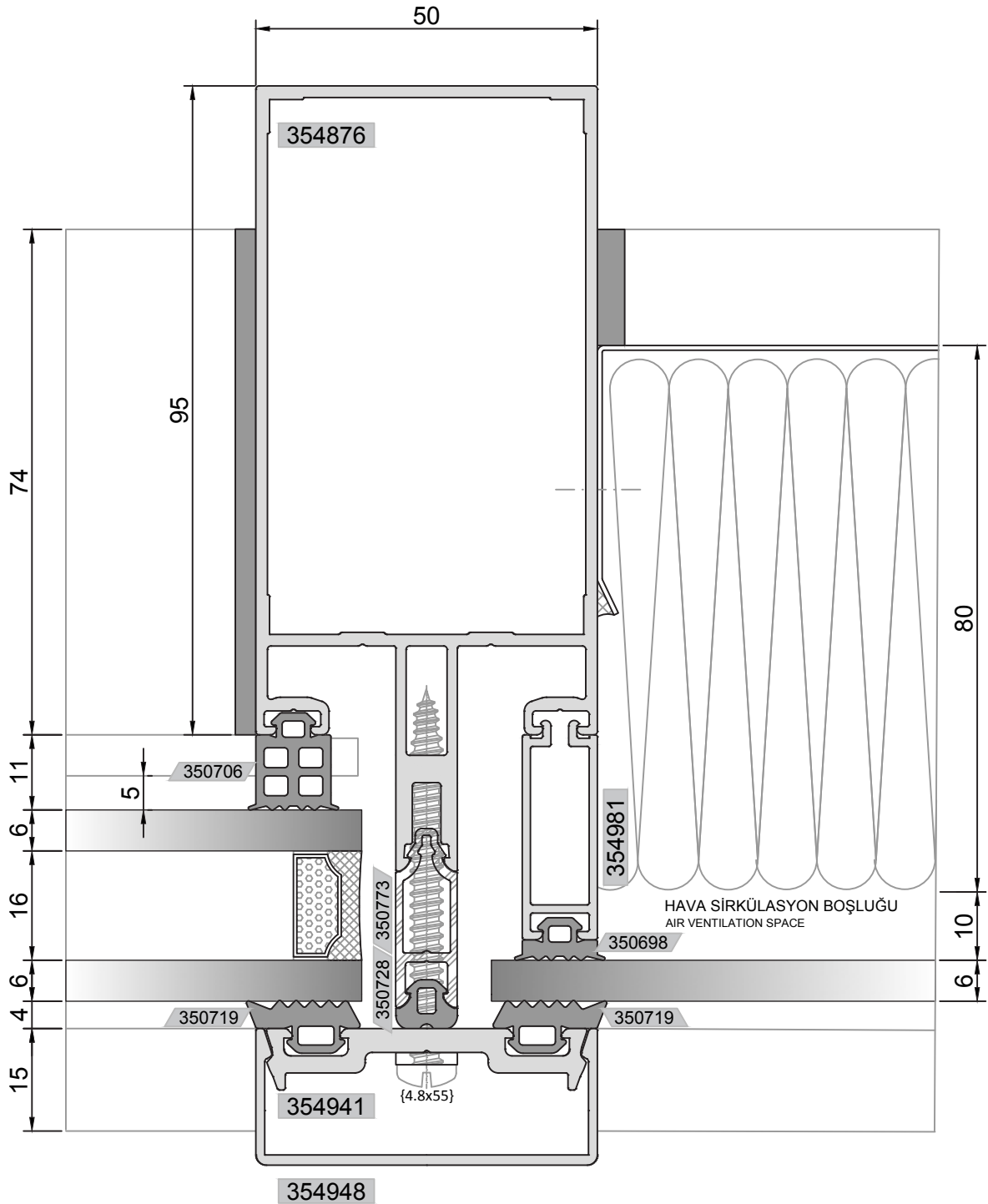

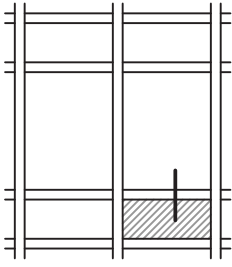

SPANDREL BÖLGE YATAY DETAYI
SPANDREL AREA HORIZONTAL DETAIL

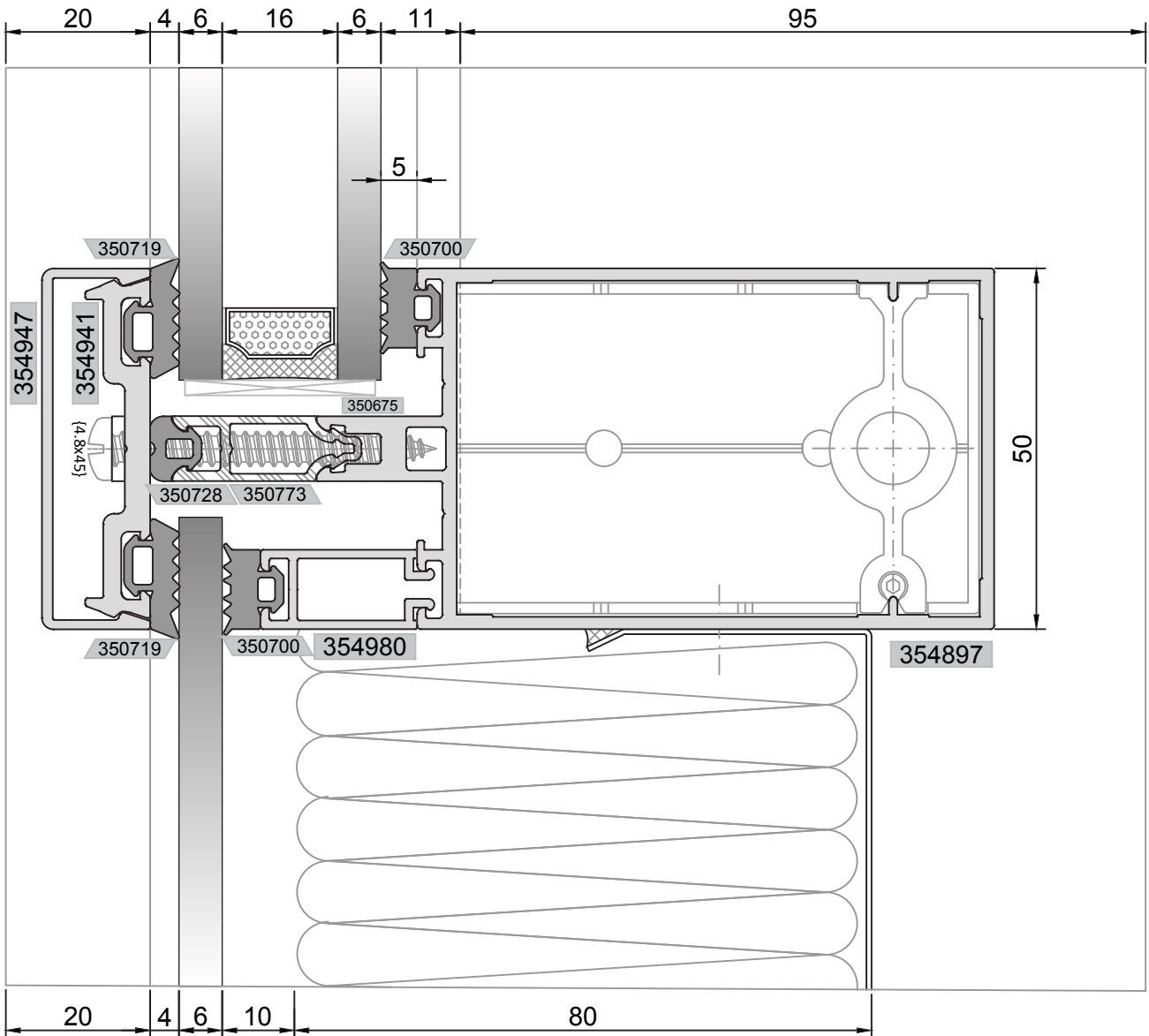

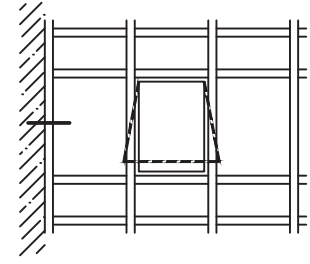

DUVAR BİTİŞ DETAYI
WALL JOINT DETAIL

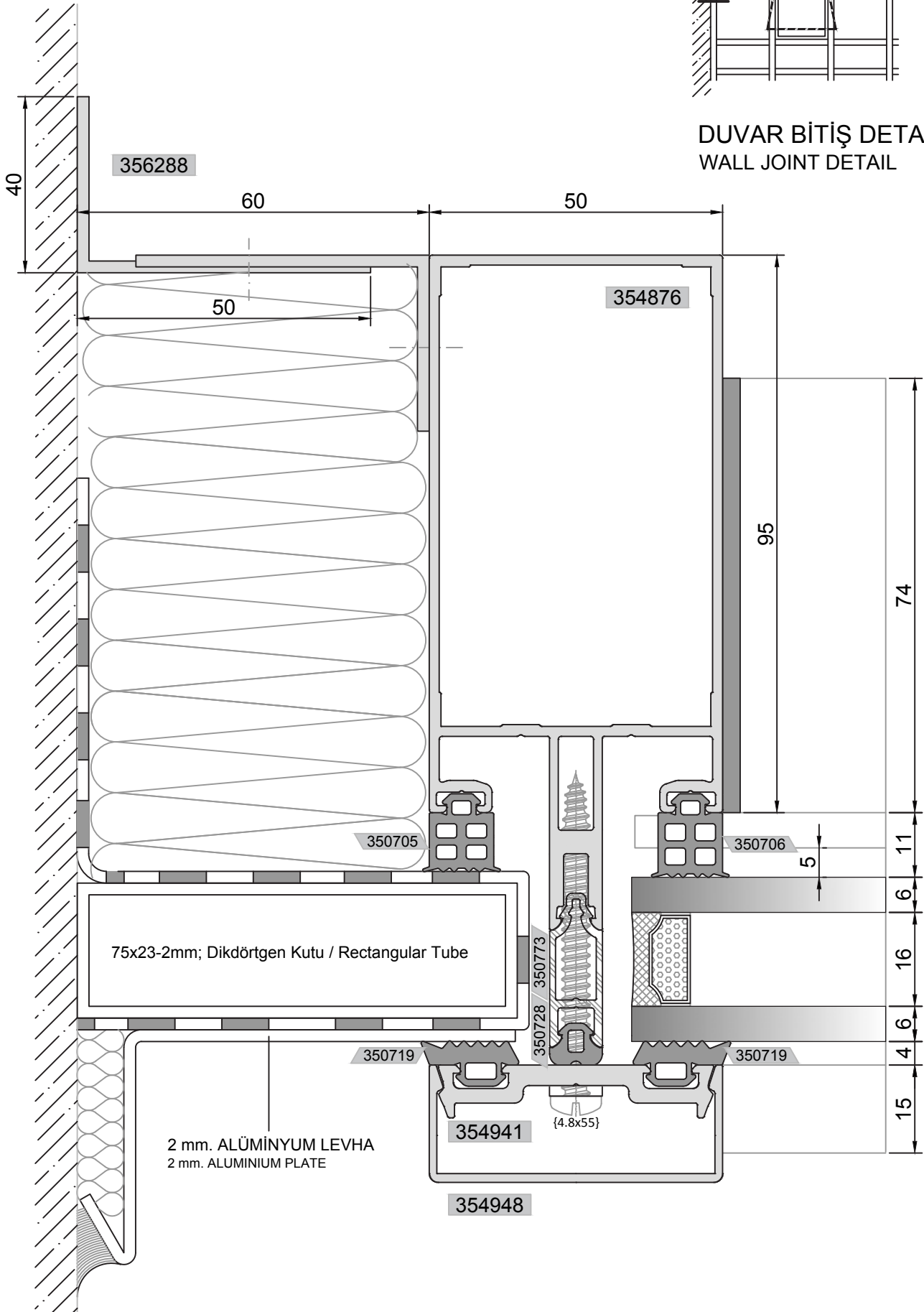

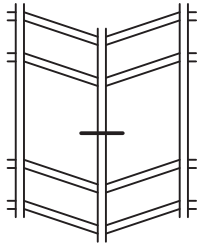

0° - 10°

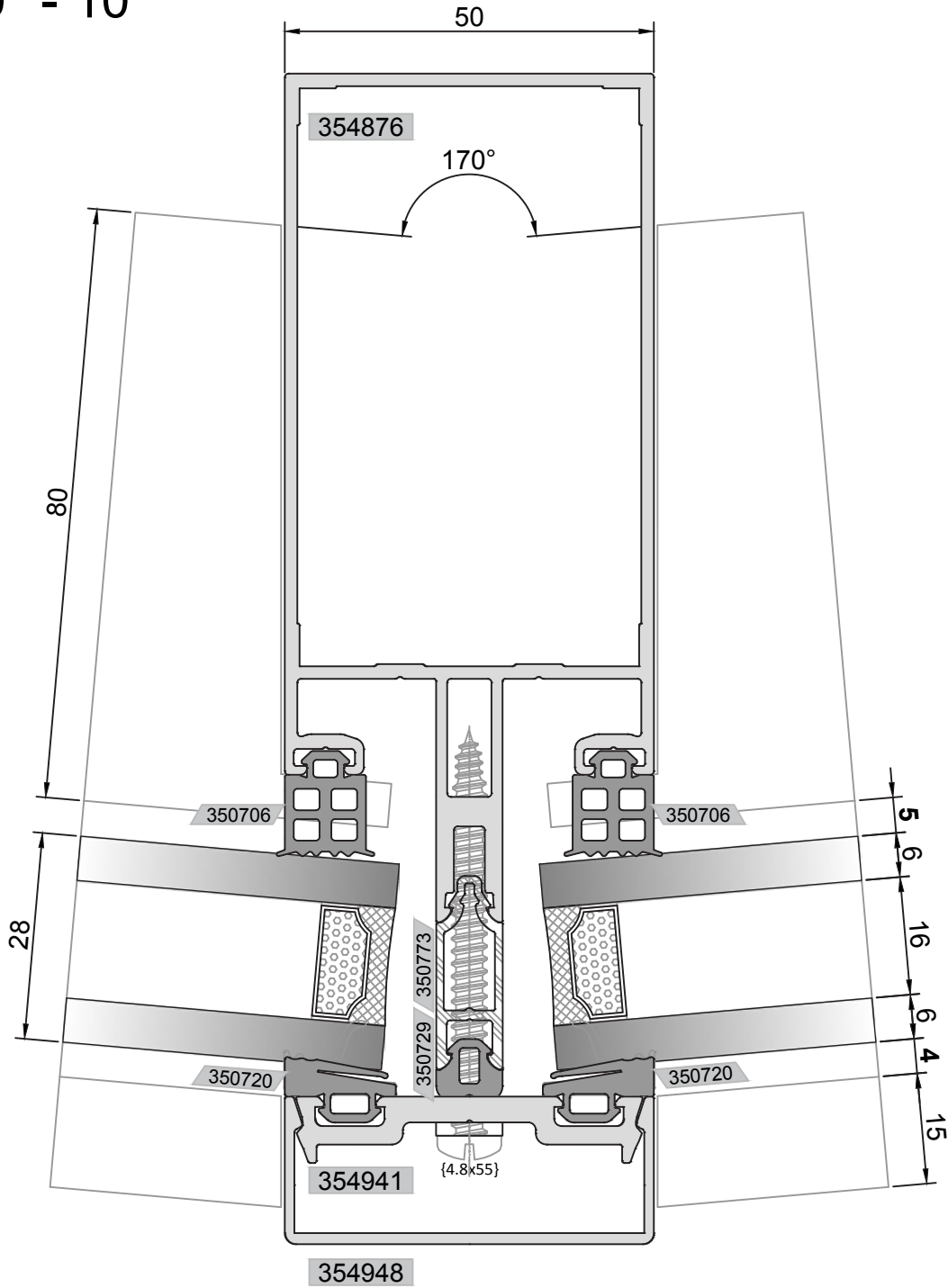

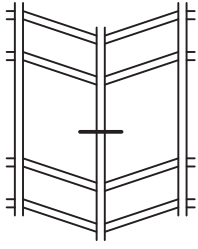

10° - 30°

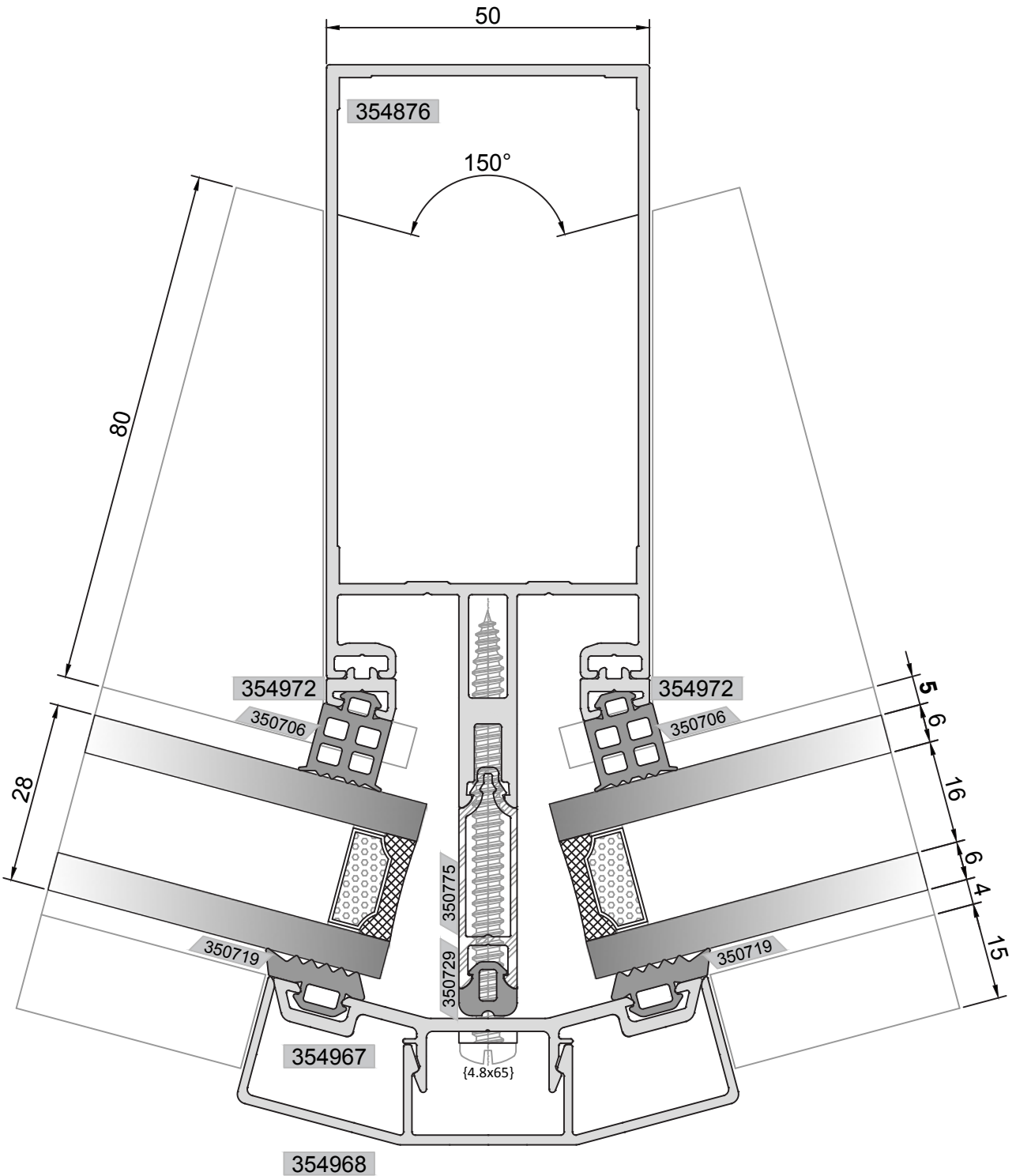

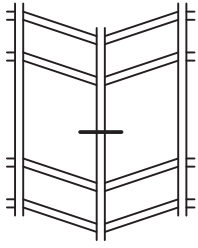

30° - 60°

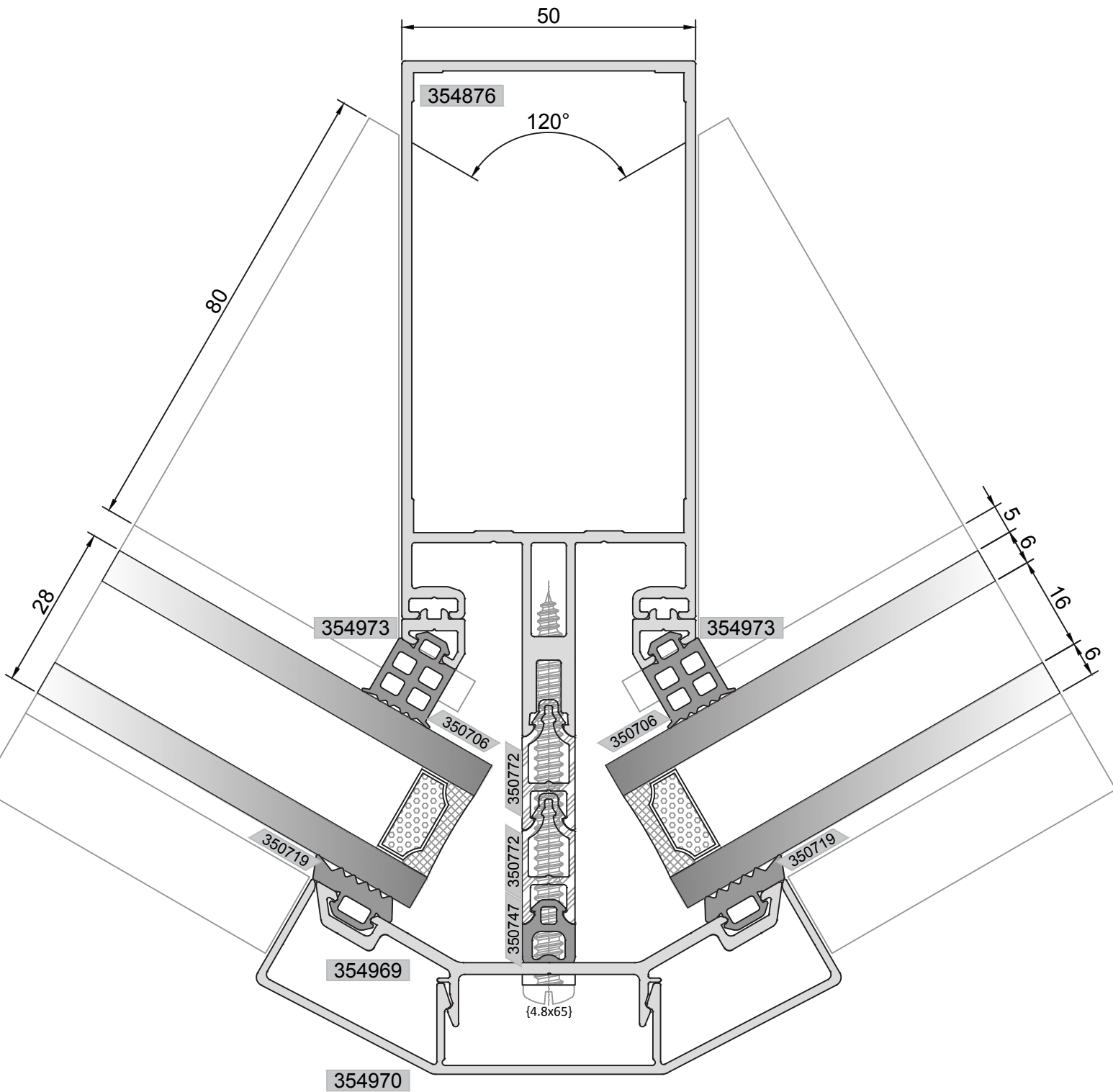

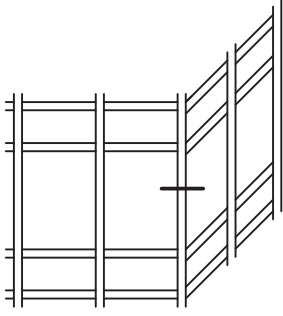

ALTERNATİF 1: TEK KAPAKLI KÖŞE DETAYI
ALTERNATIVE 1 : CORNER DETAIL WITH SINGLE CAP

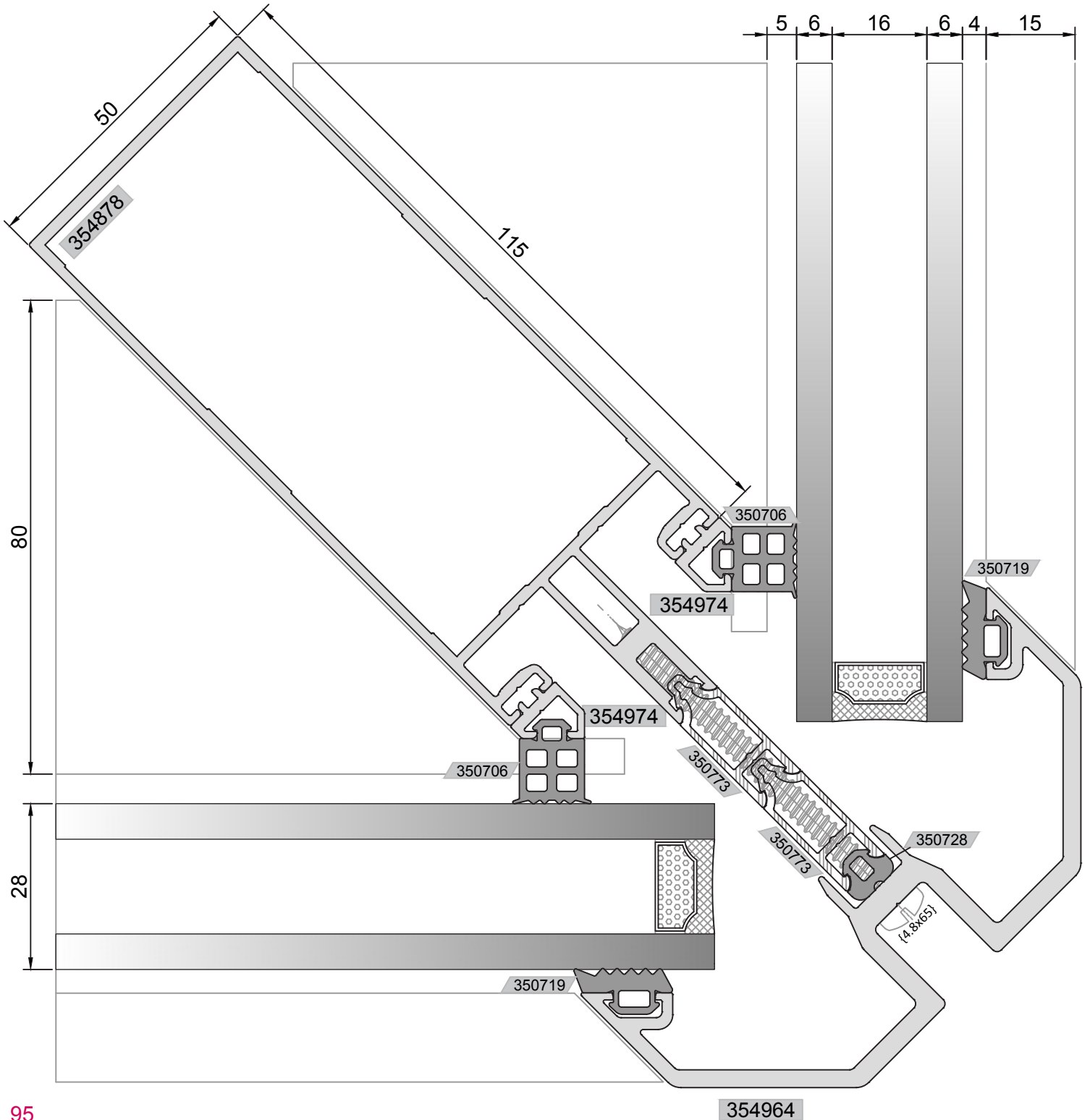

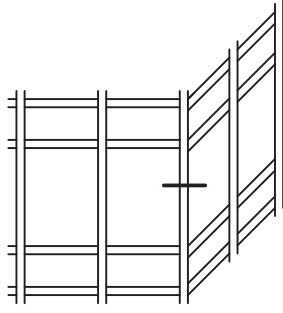

ALTERNATİF 2: ÇİFT KAPAKLI KÖŞE DETAYI
ALTERNATIVE 2 : CORNER DETAIL WITH DOUBLE CAP

90°

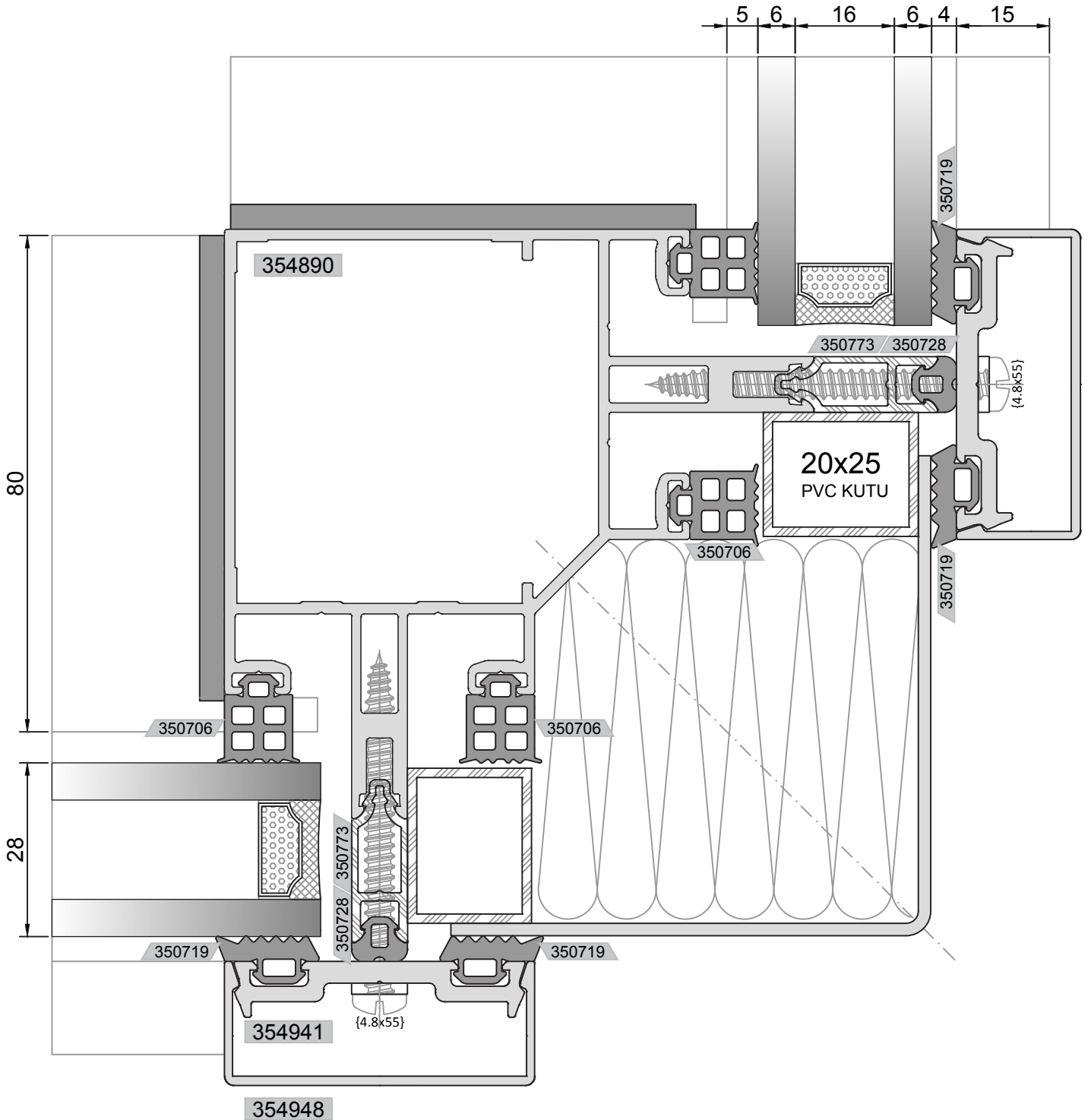

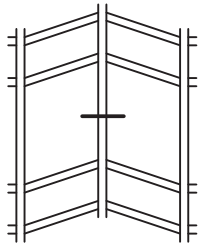

10° - 0°

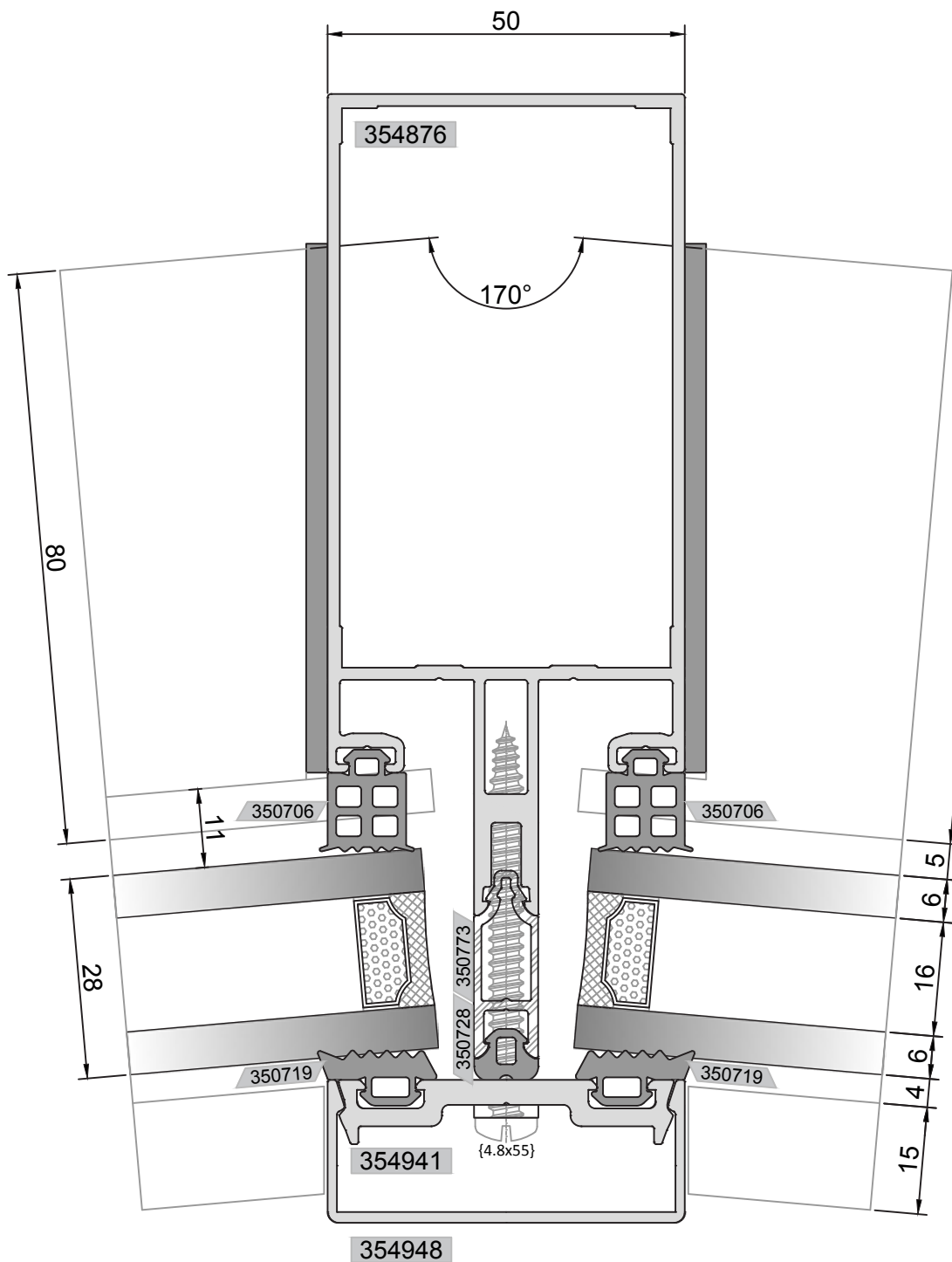

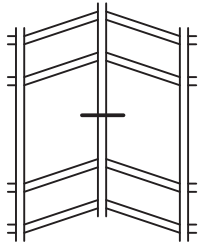

20° - 10°

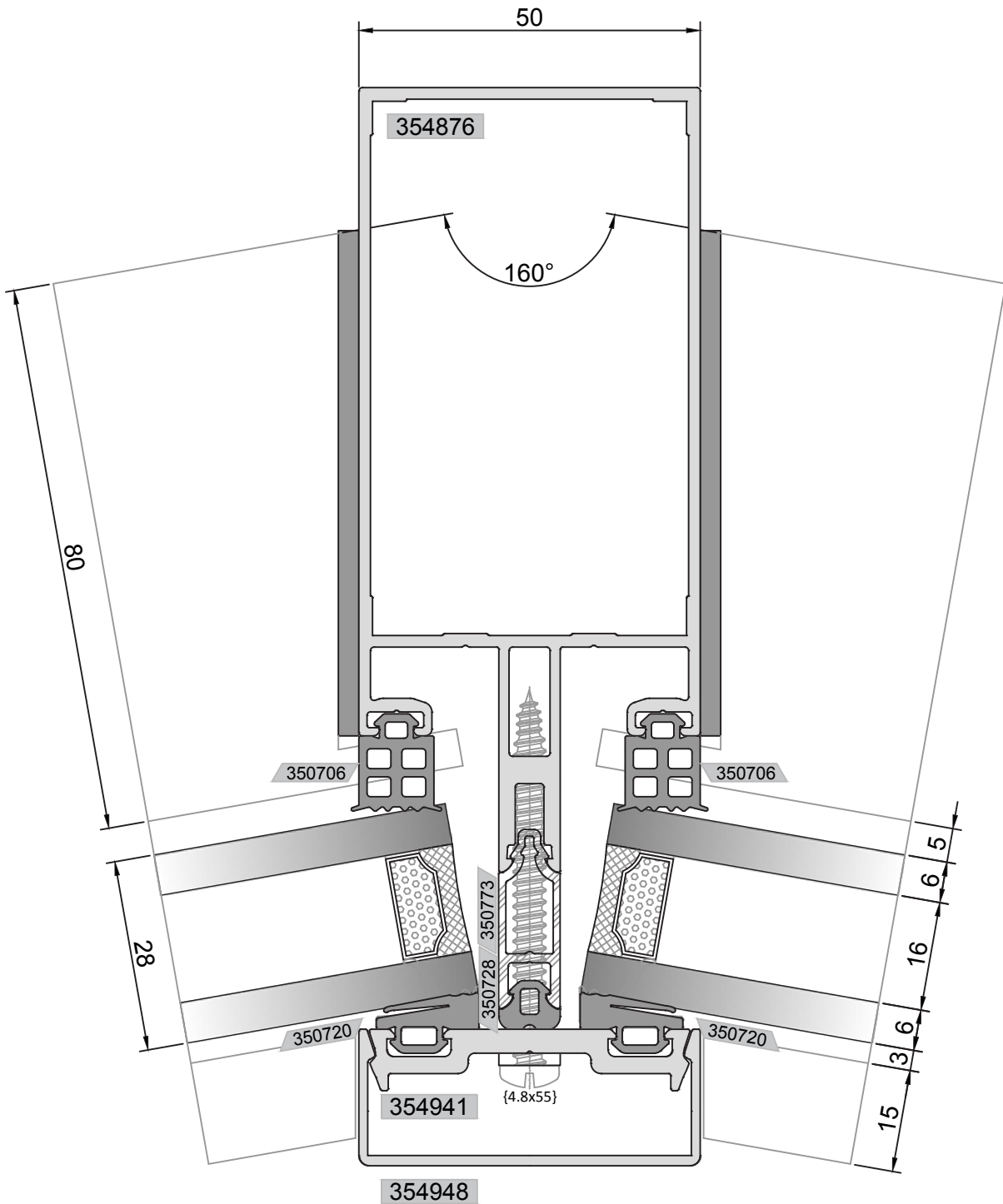

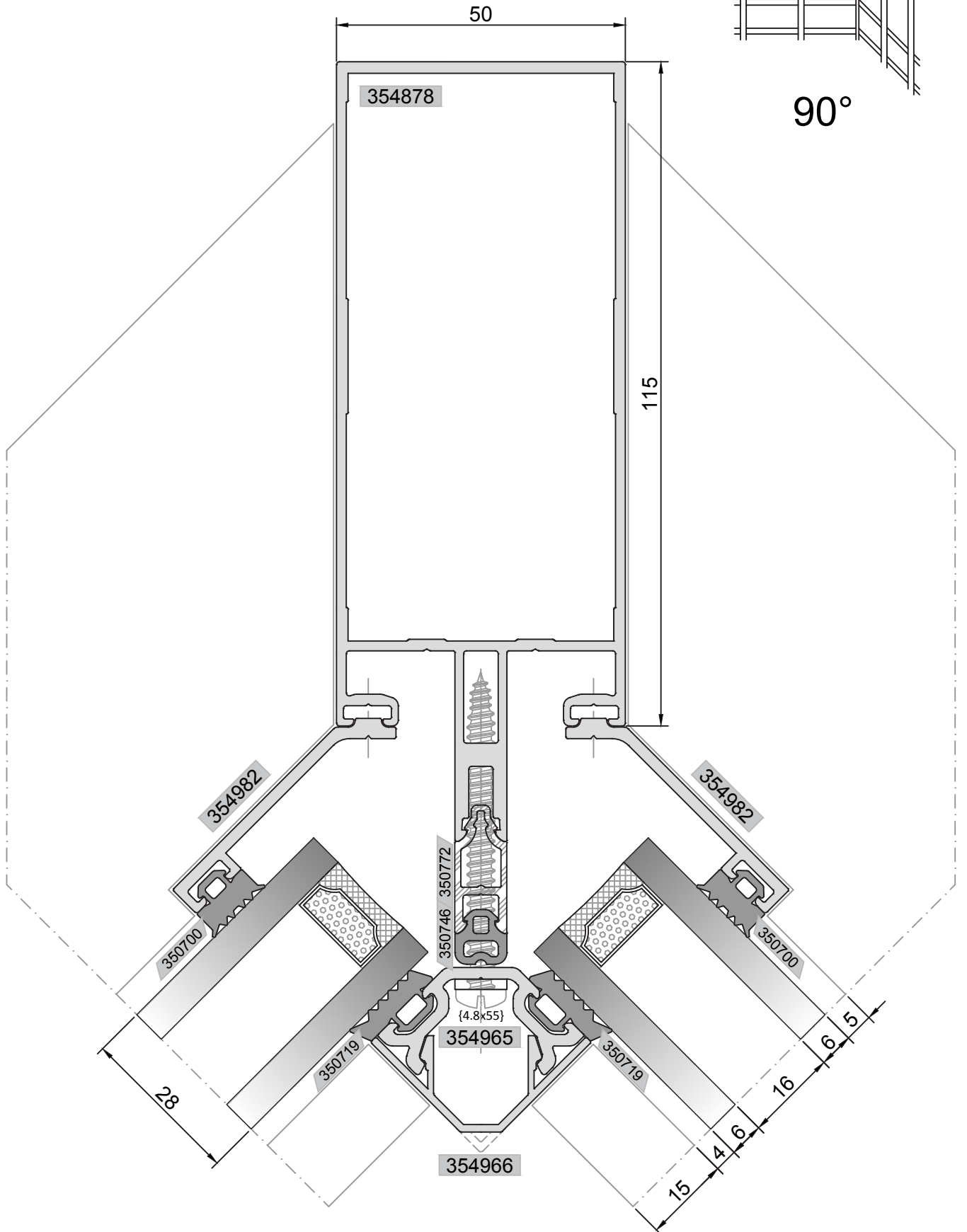
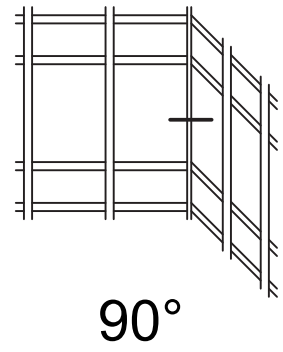

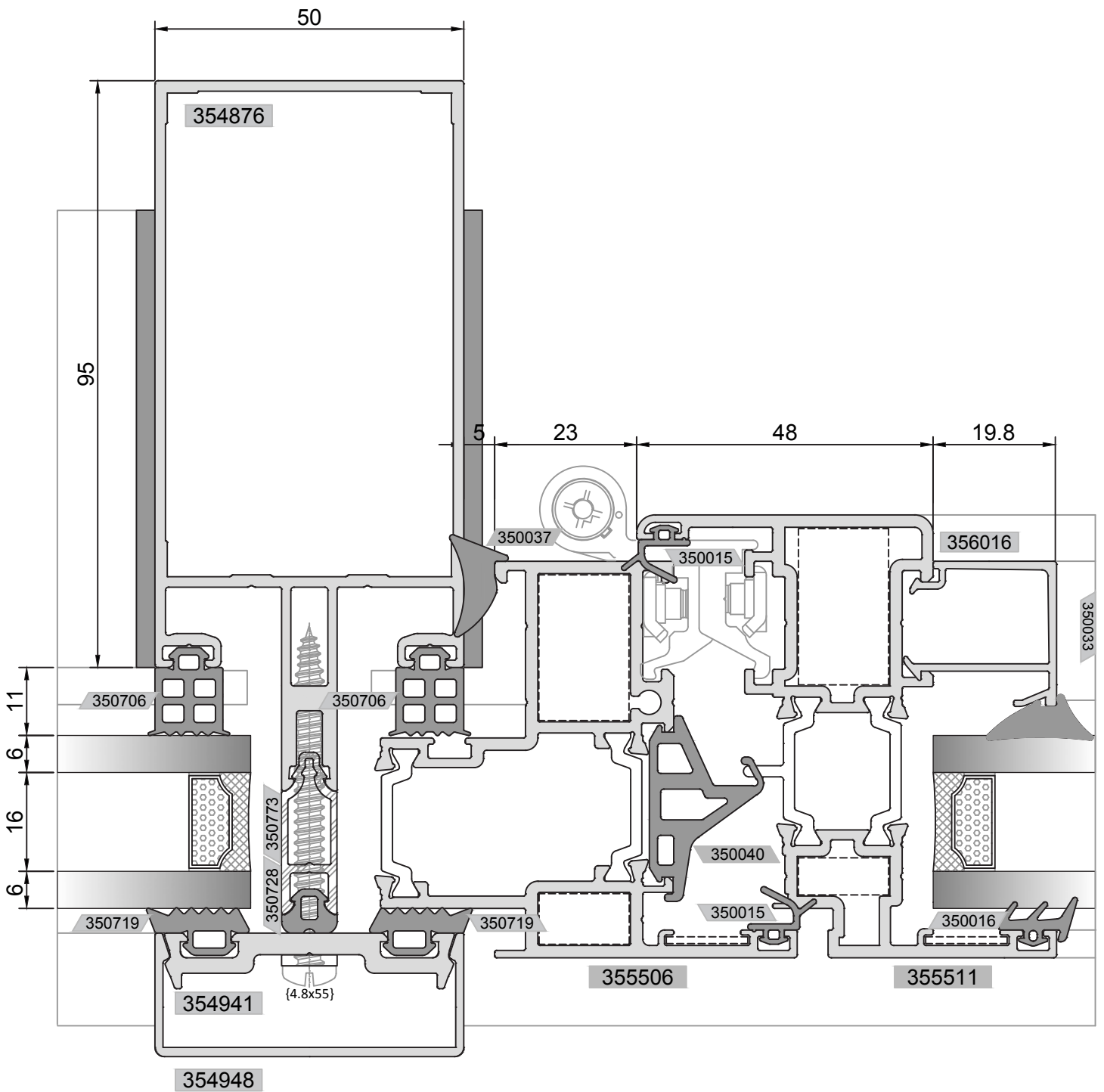
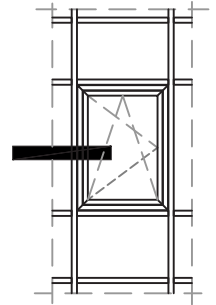

KAPAKLI CEPHE / CAPPED CURTAIN WALL

