

KOMPOZİT PANEL TAŞIYICI SİSTEMLERİ

354618

938 gr./m.

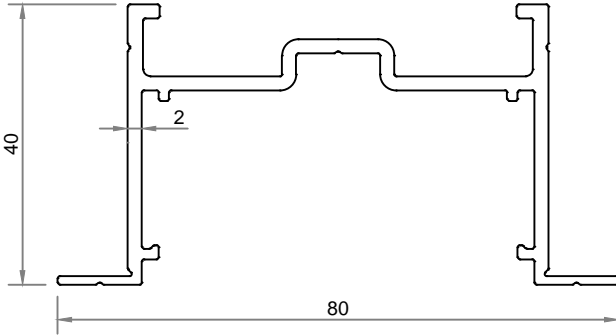

354619

984 gr./m.

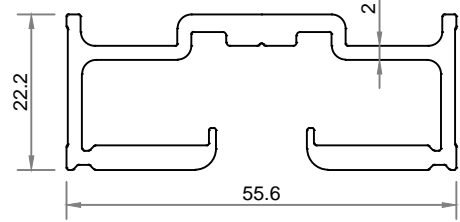

351144	20 mm	6x12 mm setiskur vida
--------	-------	-----------------------

354620

1330 gr./m.

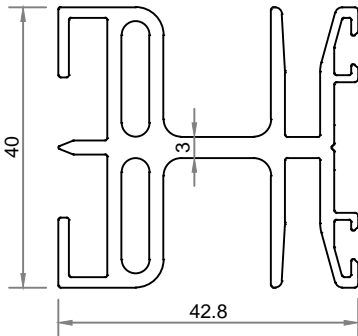

351145	8 mm	100 adet/pcs	350068 epdm
--------	------	--------------	-------------

354621

253 gr./m.

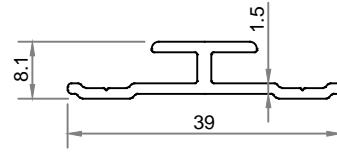

354622

239 gr./m.

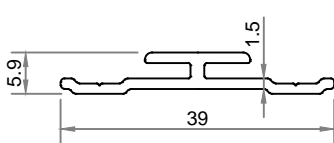

354623

207 gr./m.

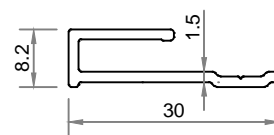

IQ-3100 CONEXUS

KOMPOZİT PANEL TAŞIYICI SİSTEMLERİ

354624 259 gr./m.

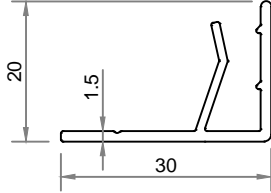

354625 215 gr./m.

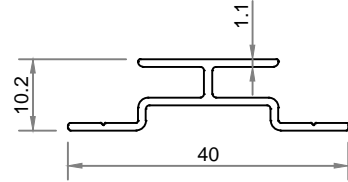

354626 897 gr./m.

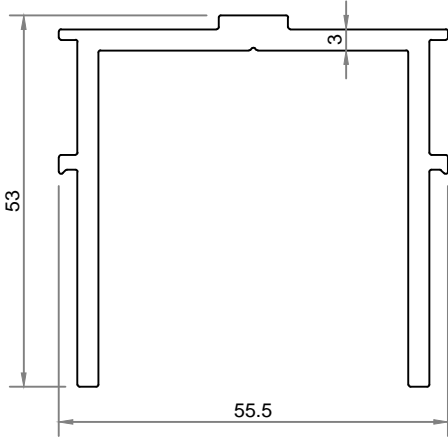

351146	40 mm	8 mm boru profil 6x12 mm setiskur vida
--------	-------	---

354627 137 gr./m.

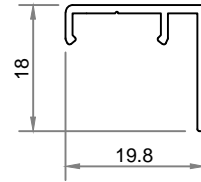

354628 148 gr./m.

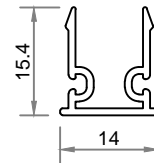

354629 256 gr./m.

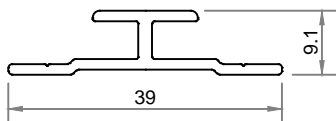

354630 725 gr./m.

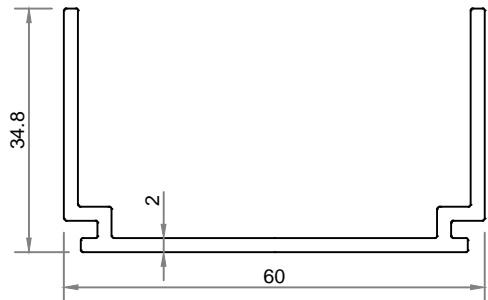

351147	80 mm
--------	-------

IQ-3100 CONEXUS

KOMPOZİT PANEL TAŞIYICI SİSTEMLERİ

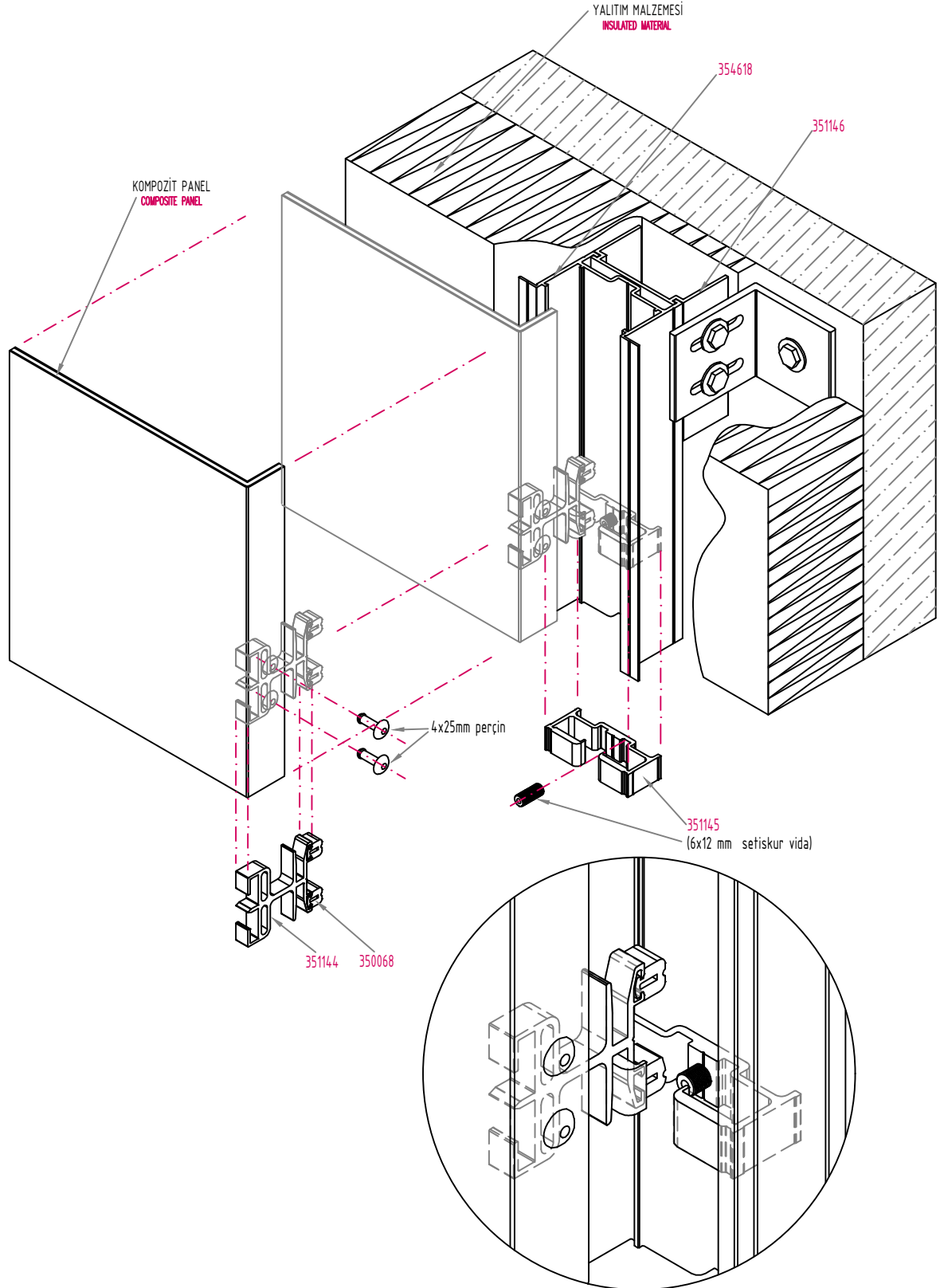

KOMPOZİT PANEL TAŞIYICI SİSTEMLERİ

354618

938 gr./m.

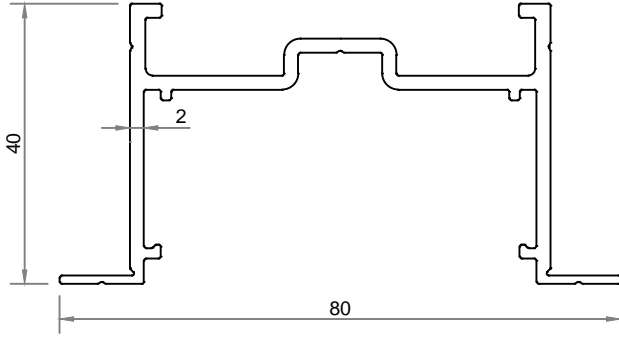

354630

725 gr./m.

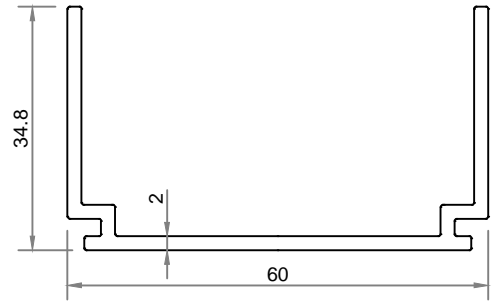

351147	80 mm
--------	-------

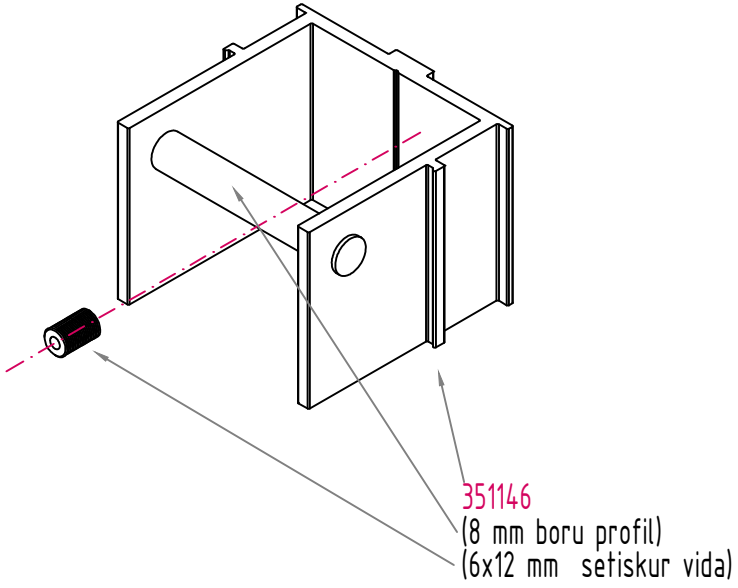

354626

897 gr./m.

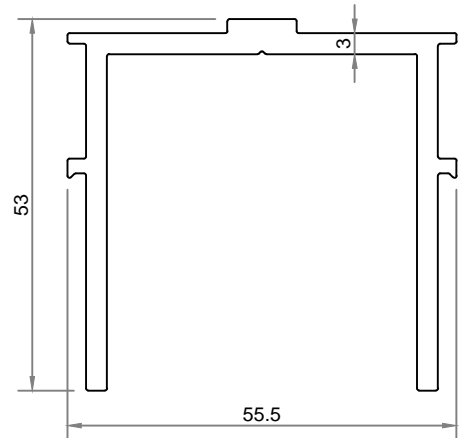

351146	40 mm	8 mm boru profil 6x12 mm setiskur vida
--------	-------	---

IQ-3100 CONEXUS

KOMPOZİT PANEL TAŞIYICI SİSTEMLERİ

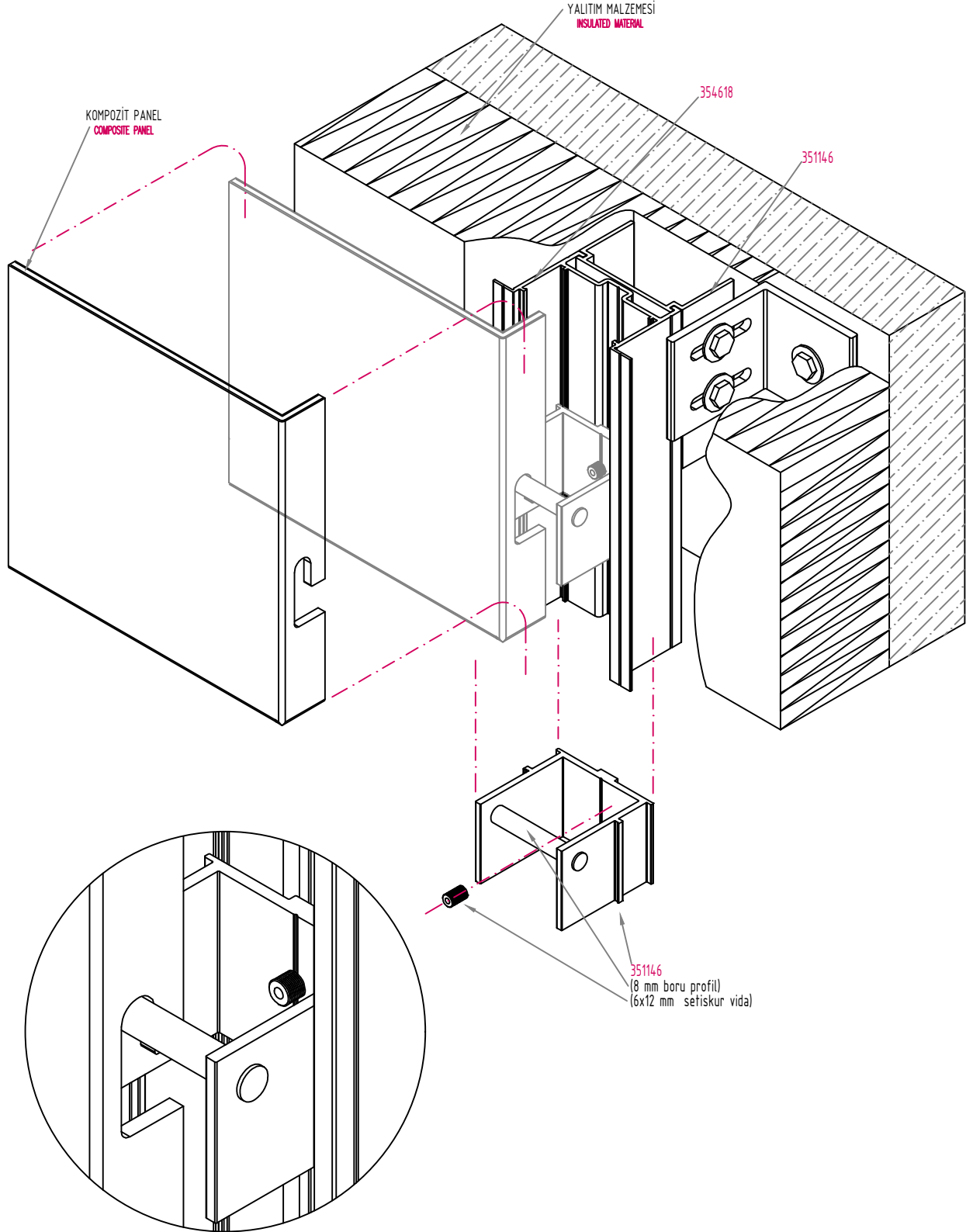

354627 137 gr./m.

354628 148 gr./m.

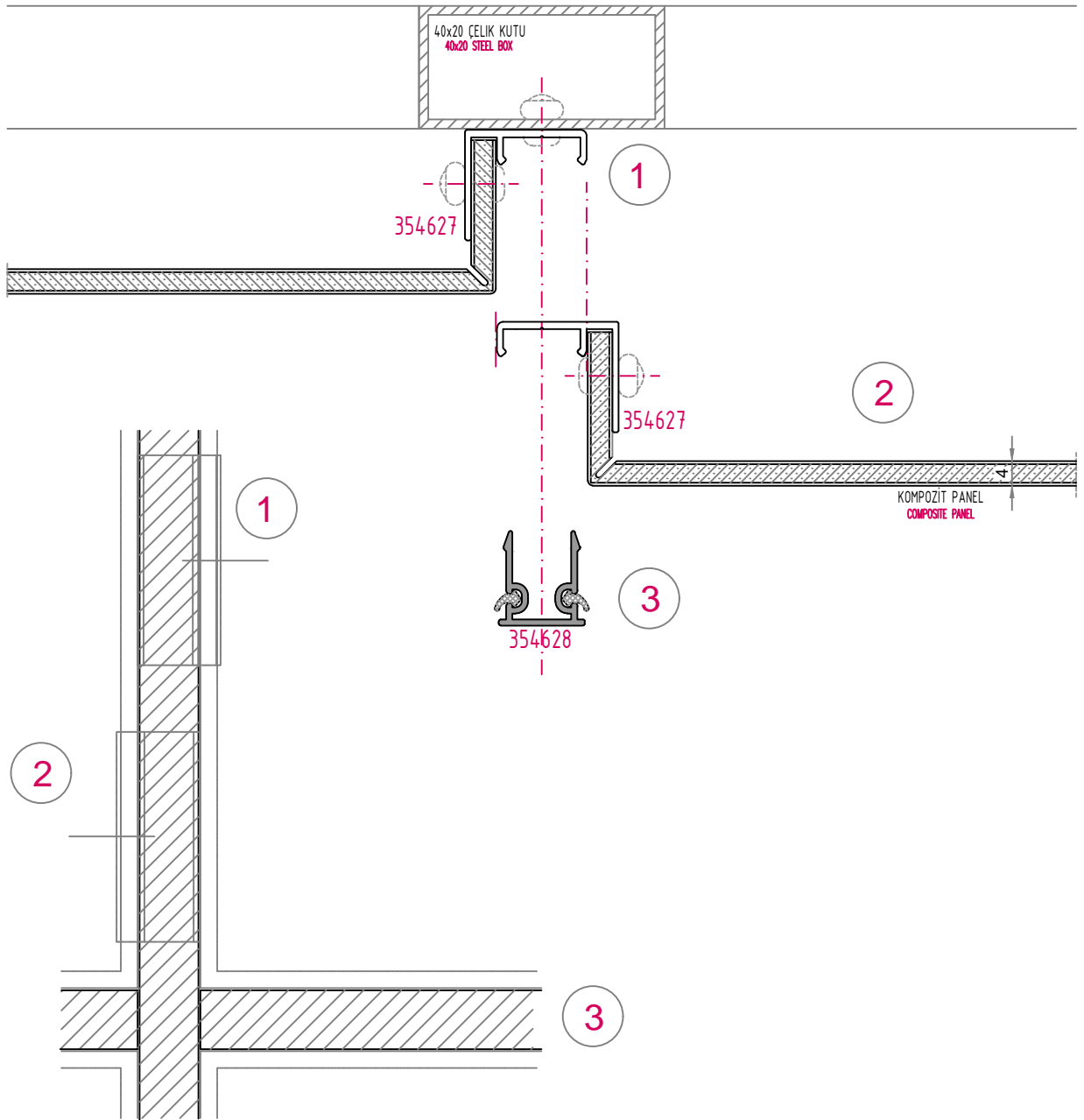
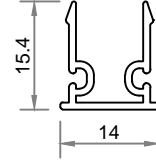
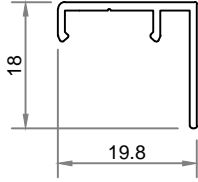

IQ-3100 CONEXUS

KOMPOZİT PANEL TAŞIYICI SİSTEMLERİ

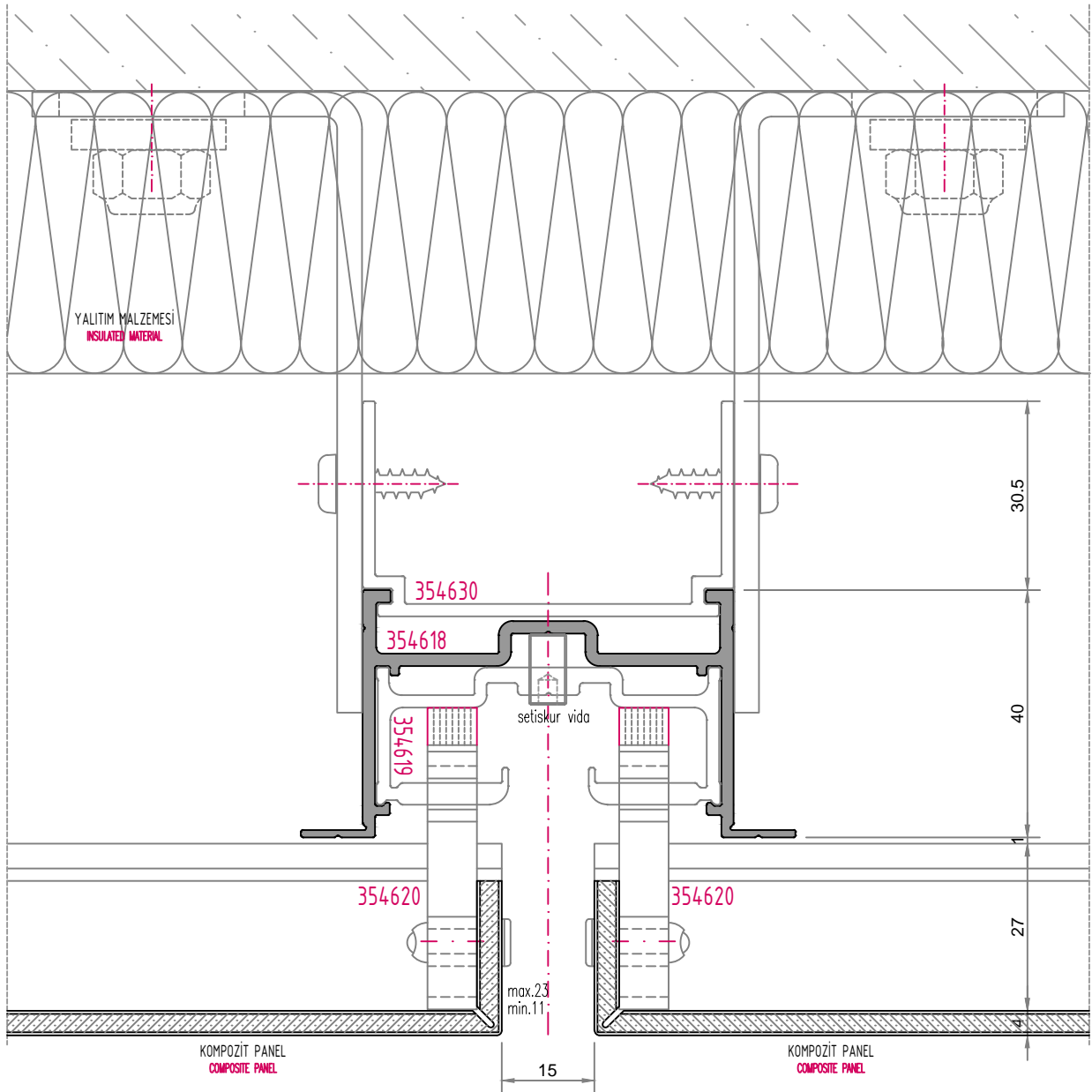
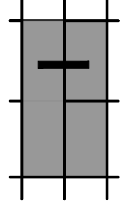

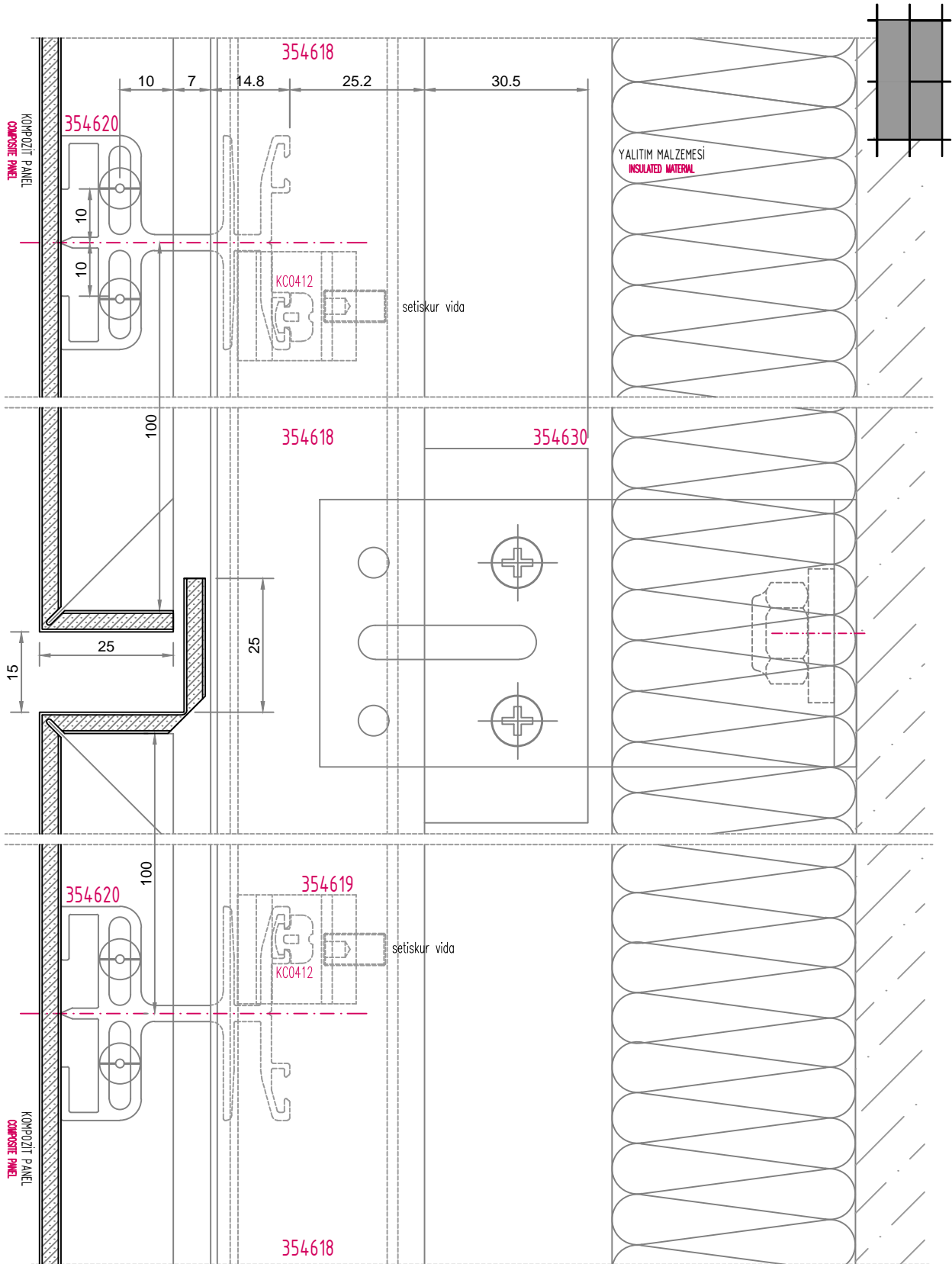

IQ-3100 CONEXUS

KOMPOZİT PANEL TAŞIYICI SİSTEMLERİ

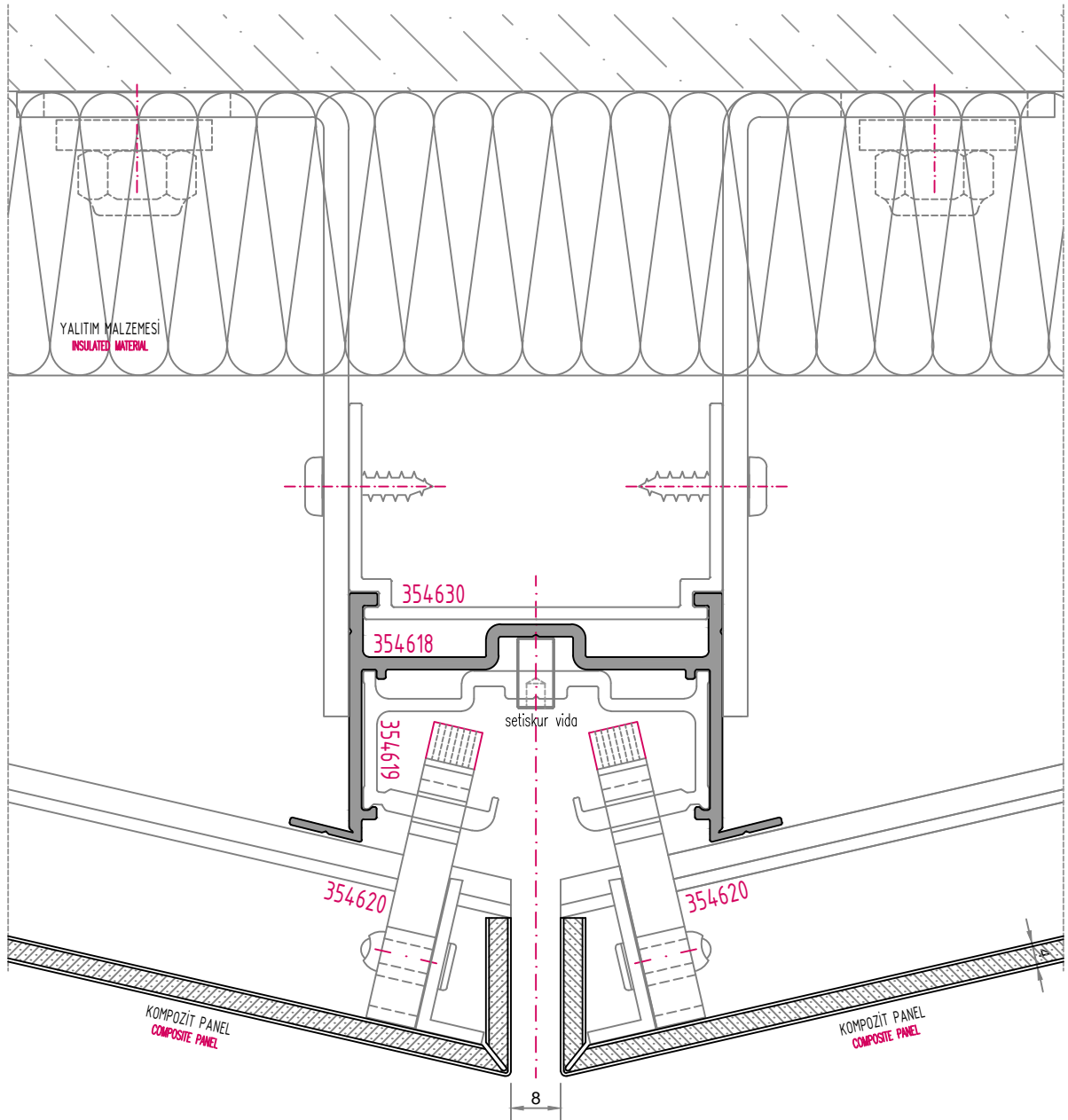
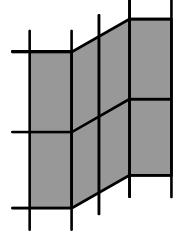

IQ-3100 CONEXUS

KOMPOZİT PANEL TAŞIYICI SİSTEMLERİ

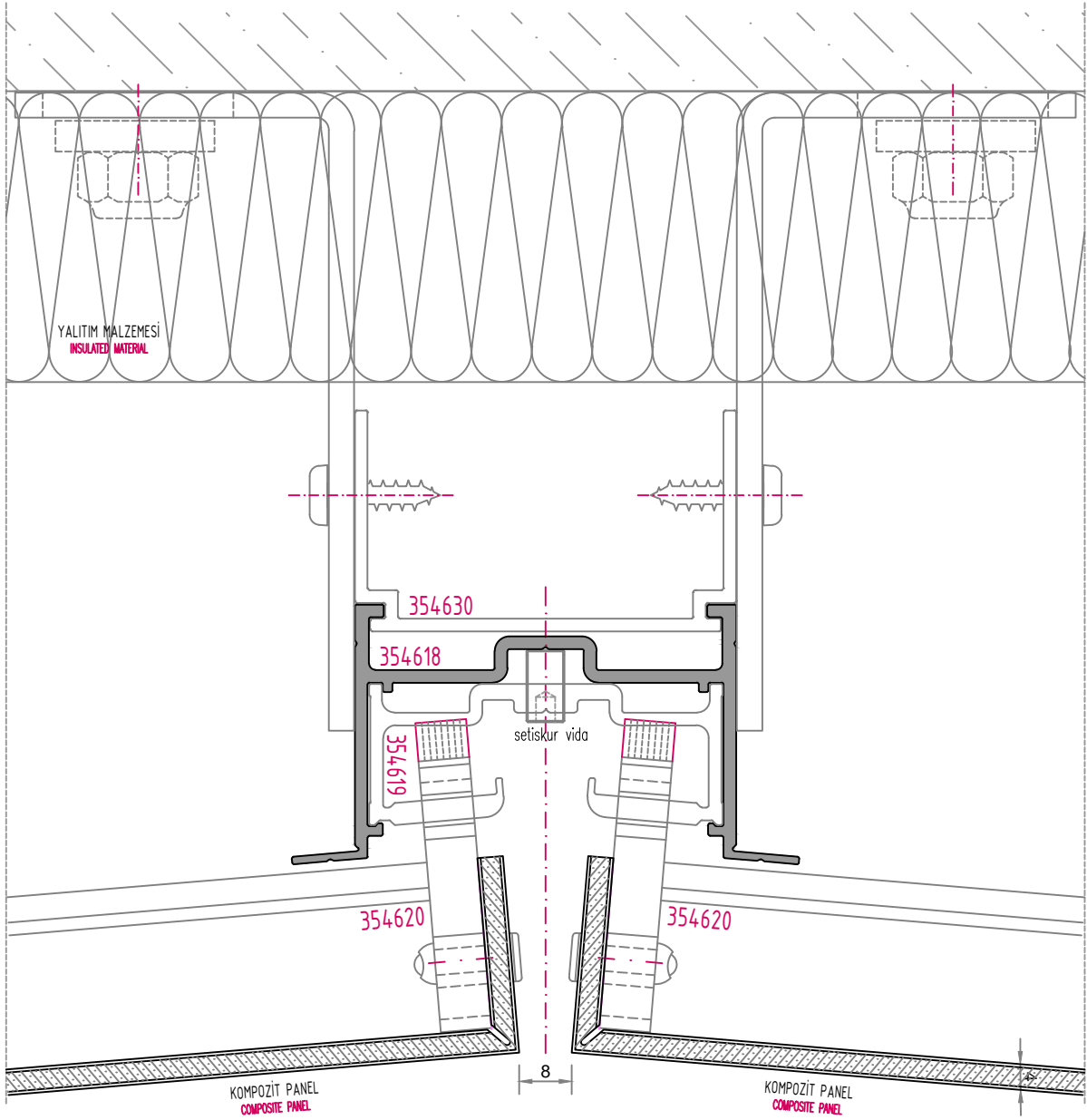
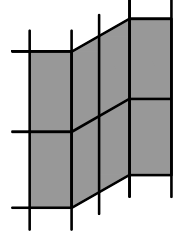

IQ-3100 CONEXUS

KOMPOZİT PANEL TAŞIYICI SİSTEMLERİ

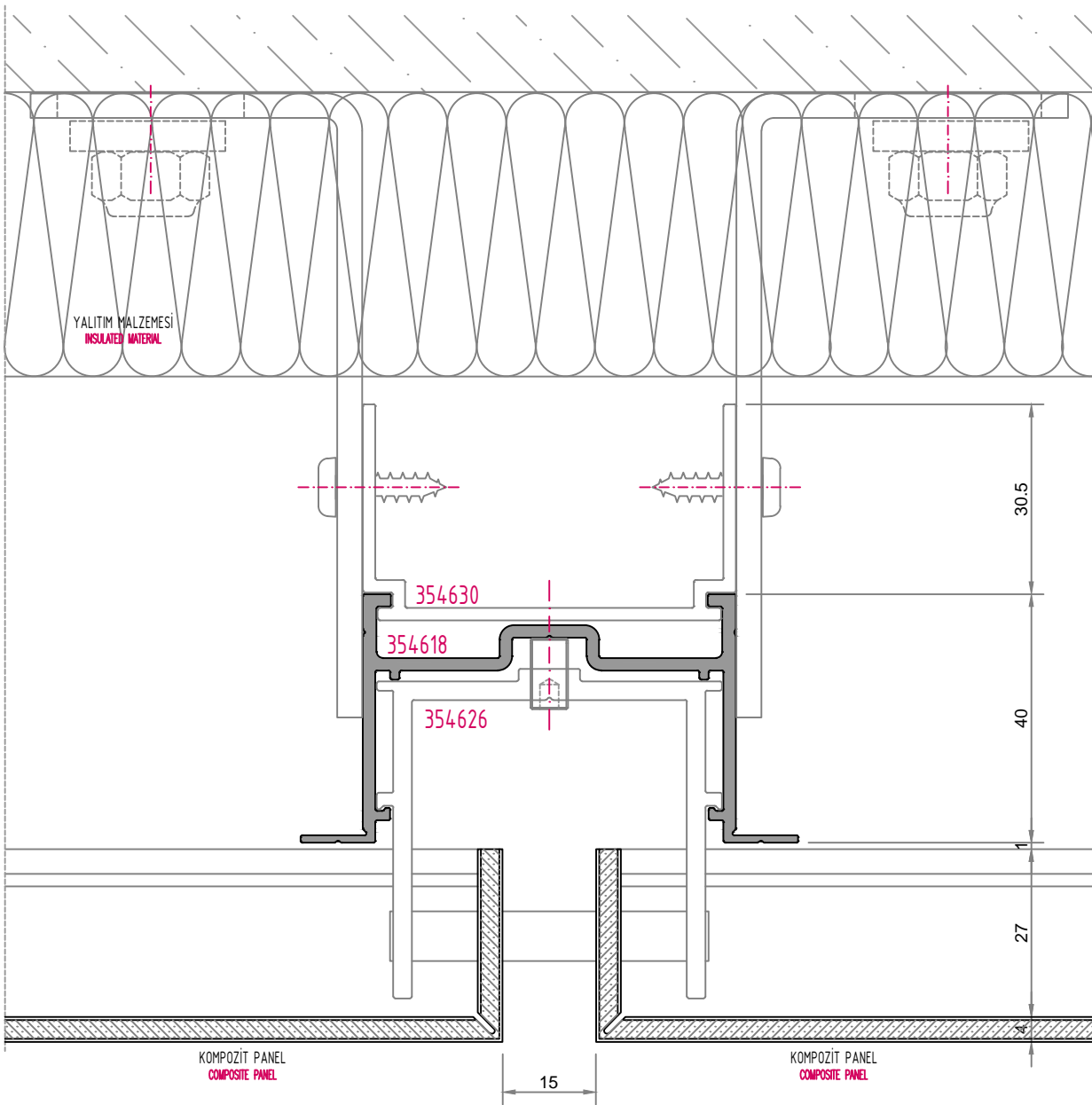
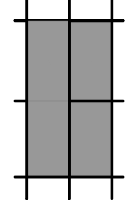

IQ-3100 CONEXUS

KOMPOZİT PANEL TAŞIYICI SİSTEMLERİ

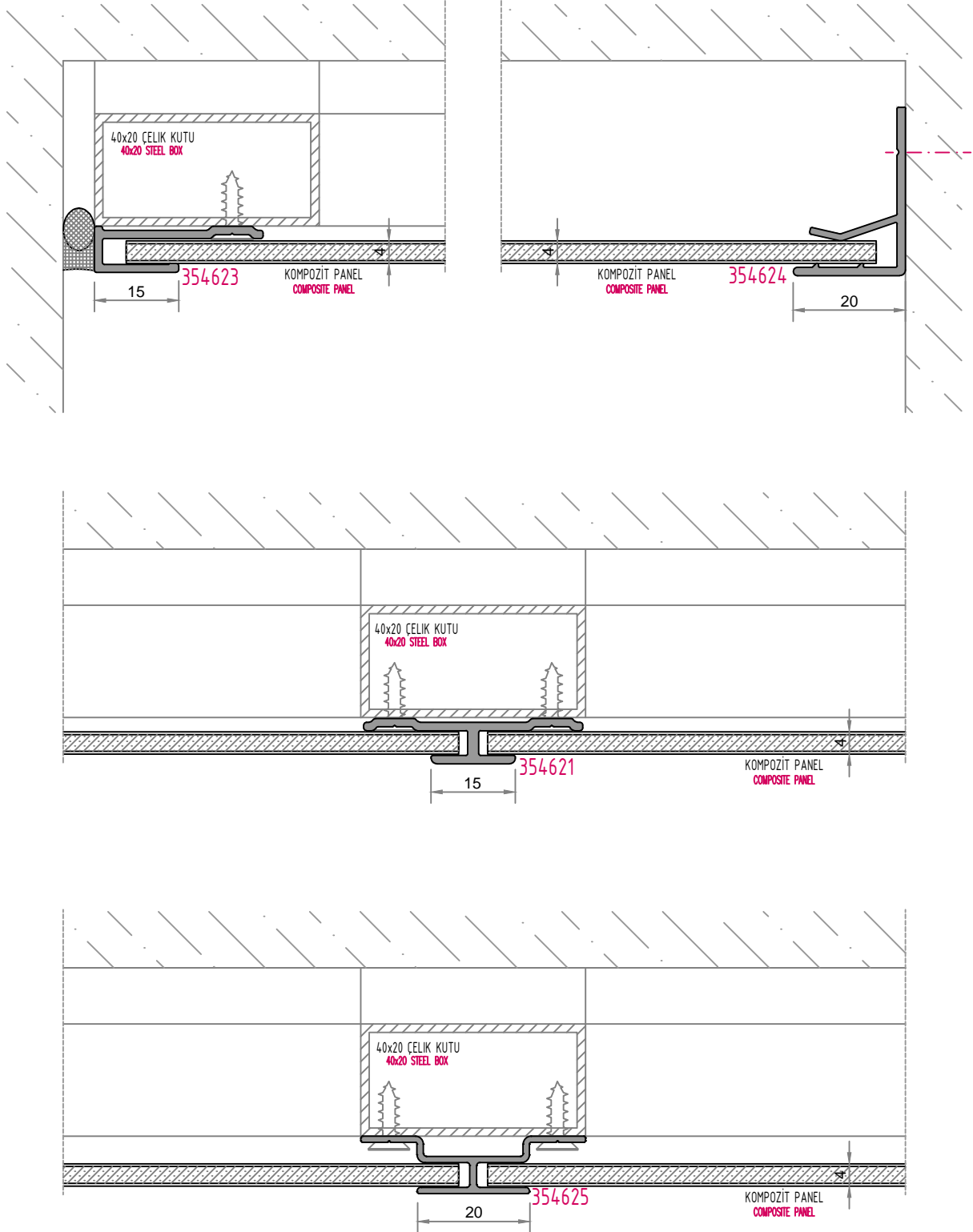

IQ-3100 CONEXUS

KOMPOZİT PANEL TAŞIYICI SİSTEMLERİ

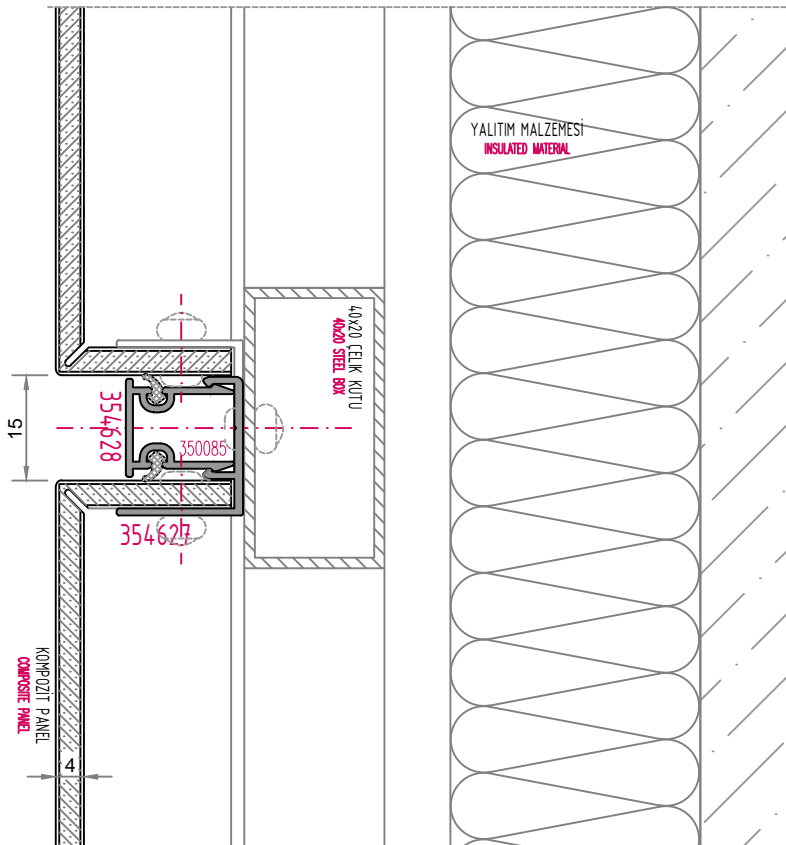
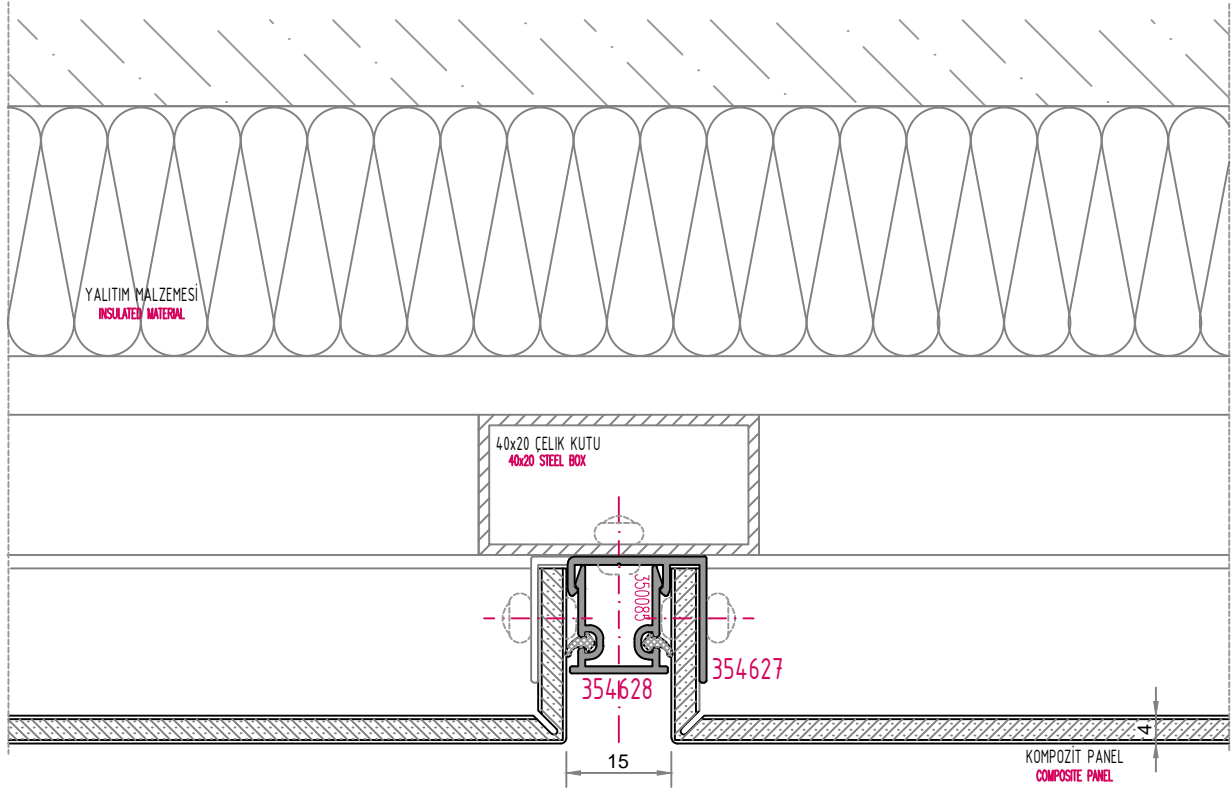

IQ-3100 CONEXUS
KOMPOZİT PANEL TAŞIYICI SİSTEMLERİ

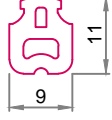
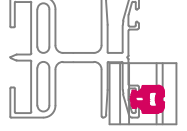
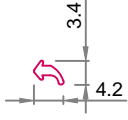
KOD	ŞEKİL	TANIM	METRAJİ	KULLANIM YERİ
35086		Taşıyıcı Ön Fitol		
35085		Profil İç Fitol		